

ORGANIZE SPACE LET'S REORG

- **DRAWER CABINETS SERIES STANDARD**
- **CABINETS WITH DOORS SERIES STANDARD**
- **COMPUTER CABINETS SERIES STANDARD**

NORMAL EXTENSION DRAWER 87% OR TELESCOPIC FULL EXTENSION 100%

STRONG AND RELIABLE THROUGH TIME

SEVERAL SERIES AVAILABLE



ORGANIZE SPACE LET'S REOR

STANDARD

LOCKS



■ This type of lock can be assembled to all drawers of the series STANDARD cabinets



■ 07

DRAWERS SINGLE LOCK

ORD. NO.

F AG 9199 00 07

Complete with:

1 steel support

1 cylinder lock

with 2 keys series 45

Lock available in black RAL 9011.



■ 01
■ 02
■ 04
■ 08

SECURITY SHELF BETWEEN DRAWERS

ORD. NO.

FOR CABINETS SERIES

F AG 9190 00 04

F DD 10 (27x36 EH)

F AG 9188 00 04

F AG 20 (36x36 EH)

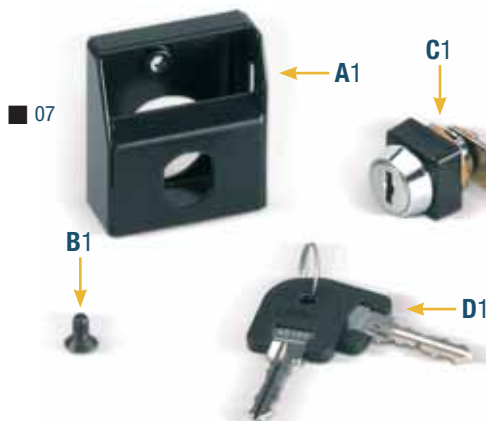

SPARE LOCK

SUPPORT

ORD. NO.

REFERENCE

R XAG 0009 07

A1+B1

LOCK

ORD. NO.

REFERENCE

R CSR 0034 00

C1+D1

RAL 7000 F... ..01 RAL 6011 F... ..02 RAL 5012 F... ..04 RAL 7035 F... ..08

SUPPLEMENTARY PARTS ■

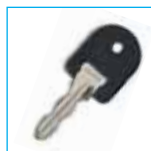
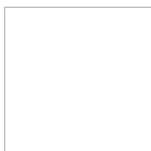
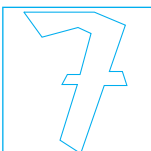

■ **Spare key.** Always indicate the number on the cylinder lock of the key to be replaced.

ORD. NO. R CSC 0002 00

■ **Master key.** This type of key opens all the 45 and 46 series locks.

ORD. NO. R CSC 0001 00





■ RAL 7035

CABINET WITH WHEELS

ORD. NO.

F DD E550 S1 08

Complete with:

4 drawers with single lock

3 security shelves

Dimensions mm 575x815x797 h

Tools and partitioning material excluded

■ INFO

RAL 7000 F... ..01

RAL 6011 F... ..02

RAL 5012 F... ..04

RAL 7035 F... ..08

■ Partitioning material: see page A180



www.famispa.com





ORD. NO. F DD 1291 S1 EF
RAL 7000+7035



ORD. NO. F DD E550 S1 08
RAL 7035

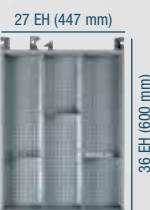

FIXING SET



2x

- 2 "HILTI" plugs for concrete floors \geq to classes B25/RBK250/MPa 25 N/mm²
- Recommended traction of the plug: 2.9 KN
- Plug diameter: \varnothing 6 mm

ORD. NO. F AG 9204 00 99

CABINET FLOOR FIXING SET

- Pair of spare galvanised brackets
- \varnothing 6 mm hole



ORD. NO. F AG 9200 00 99

CABINET

ORD. NO.

F DD 1291 S1 EF

Complete with 3 drawers

1 600 mm height door

1 adjustable shelf, 1 retractable shelf

1 MDF shelf with rubber covering

Dimensions mm 564x726x1030 h

Tools excluded

CABINET WITH WHEELS

ORD. NO.

F DD E550 S1 08

Complete with

4 drawers with single lock

3 security shelves

Dimensions mm 575x815x797 h

Partitioning material excluded

RAL 7000 F.01

RAL 6011 F.02

RAL 5012 F.04

RAL 7035 F.08

SUPPLEMENTARY PARTS ■



- Partitioning material: see page A72-A73



- **Spare key.** Always indicate the number on the cylinder lock of the key to be replaced.

ORD. NO. R CSC 0002 00

- **Master key.** This type of key opens all the 45 and 46 series locks.

ORD. NO. R CSC 0001 00



LENGTH = 564 mm DEPTH = 726 mm (27x36 Eh)

CABINETS SERIES STANDARD B



• **ORD. NO.** DRAWERS
F DD 1020 51 04 2
 Cabinet with 2 normal extension drawers
 Dim. mm 564x726x281 h Central lock



• **ORD. NO.** DRAWERS
F DD 1020 52 04 2
 Cabinet with 2 normal extension drawers
 Dim. mm 564x726x281 h Central lock



• **ORD. NO.** DRAWERS
F DD 1020 53 04 3
 Cabinet with 3 normal extension drawers
 Dim. mm 564x726x281 h Central lock



• **ORD. NO.** DRAWERS
F DD 1030 51 04 2
 Cabinet with 2 normal extension drawers
 Dim. mm 564x726x381 h Central lock



• **ORD. NO.** DRAWERS
F DD 1030 55 04 2
 Cabinet with 2 normal extension drawers
 Dim. mm 564x726x381 h Central lock



• **ORD. NO.** DRAWERS
F DD 1030 52 04 3
 Cabinet with 3 normal extension drawers
 Dim. mm 564x726x381 h Central lock

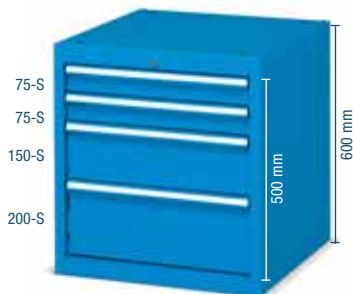

ORD. NO. DRAWERS
F DD 1050 52 04 4
 Cabinet with 4 normal extension drawers
 Dim. mm 564x726x600 h Central lock



ORD. NO. DRAWERS
F DD 1050 53 04 5
 Cabinet with 5 normal extension drawers
 Dim. mm 564x726x600 h Central lock



RAL 7035

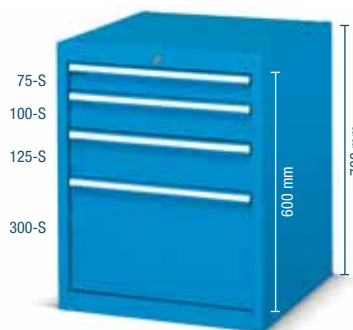

• **ORD. NO.** DRAWERS
F DD 1060 54 04 4
 Cabinet with 4 normal extension drawers
 Dim. mm 564x726x700 h Central lock



• **ORD. NO.** DRAWERS
F DD 1060 51 04 5
 Cabinet with 5 normal extension drawers
 Dim. mm 564x726x700 h Central lock

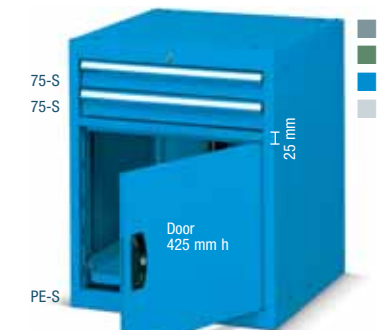

• **ORD. NO.** DRAWERS
F DD 1160 51 04 2
 Cabinet with 2 normal extension drawers
 1 normal retractable shelf
 Dim. mm 564x726x700 h Central lock

KEY

RAL 7000 F... ..01 RAL 6011 F... ..02 RAL 5012 F... ..04 RAL 7035 F... ..08



- The cabinets must be secured to the floor or to the wall.
- PE-S = normal retractable shelf (87%)
- S = normal extension (87%)



■ Detail of the normal retractable shelves (PE-S) with load capacity of 70 kg.

■ Partitioning material: see page A72-A73

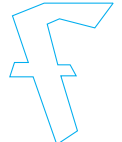

LENGTH = 564 mm DEPTH = 726 mm (27x36 Eh)

CABINETS SERIES STANDARD B

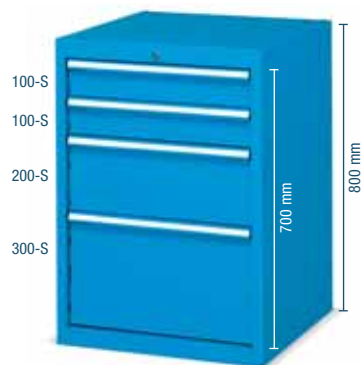

ORD. NO.

DRAWERS

F DD 1070 55 04**4**

Cabinet with 4 normal extension drawers

Dim. mm 564x726x800 h

Central lock

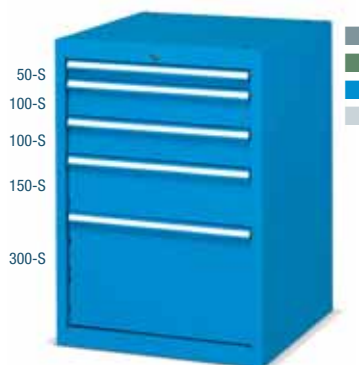

ORD. NO.

DRAWERS

F DD 1070 51 04**5**

Cabinet with 5 normal extension drawers

Dim. mm 564x726x800 h

Central lock

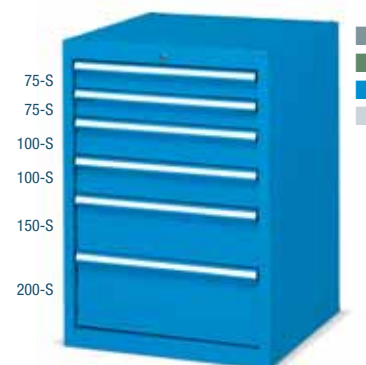

ORD. NO.

DRAWERS

F DD 1070 52 04**6**

Cabinet with 6 normal extension drawers

Dim. mm 564x726x800 h

Central lock

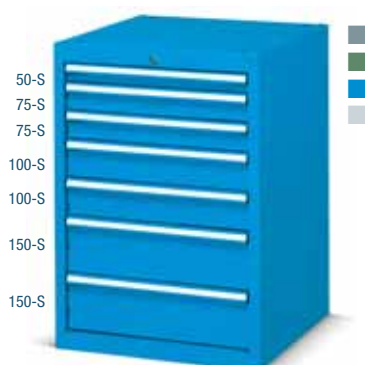

ORD. NO.

DRAWERS

F DD 1070 53 04**7**

Cabinet with 7 normal extension drawers

Dimensions mm 564x726x800 h

Central lock

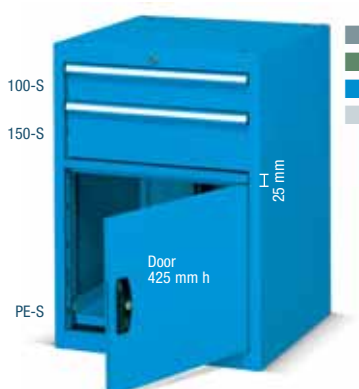

ORD. NO.

DRAWERS

F DD 1170 51 04**2**

Cabinet with 2 normal extension drawers

1 normal retractable shelf

Dim. mm 564x726x800 h

Central lock

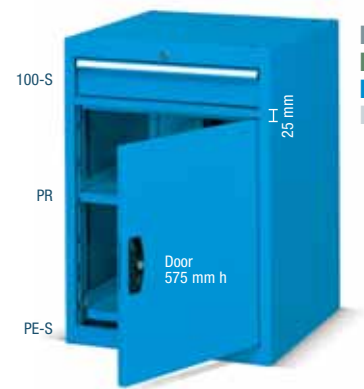

ORD. NO.

DRAWERS

F DD 1270 51 04**1**

Cabinet with 1 normal extension drawer

1 adjustable shelf, 1 normal retractable shelf

Dim. mm 564x726x800 h

Central lock

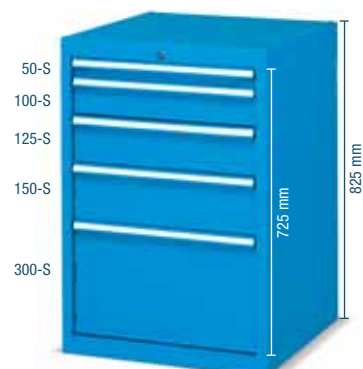

ORD. NO.

DRAWERS

F DD 1072 51 04**5**

Cabinet with 5 normal extension drawers

Dimensions mm 564x726x825 h

Central lock

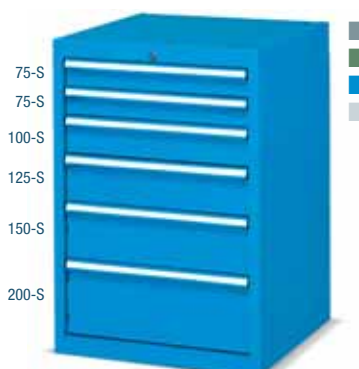

ORD. NO.

DRAWERS

F DD 1072 52 04**6**

Cabinet with 6 normal extension drawers

Dimensions mm 564x726x825 h

Central lock

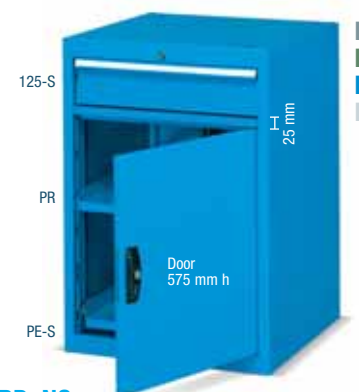

ORD. NO.

DRAWERS

F DD 1272 51 04**1**

Cabinet with 1 normal extension drawer

1 adjustable shelf, 1 normal retractable shelf

Dim. mm 564x726x825 h

Central lock

RAL 7000 F.01

RAL 6011 F.02

RAL 5012 F.04

RAL 7035 F.08

KEY ■



■ Partitioning material: see page A72-A73

■ Detail of the normal retractable shelves (PE-S) with load capacity of 70 kg.



- The cabinets must be secured to the floor or to the wall.
- PE-S = normal retractable shelf (87%)
- PR = height adjustable shelf
- S = normal extension (87%)



LENGTH = 564 mm DEPTH = 726 mm (27x36 Eh)

CABINETS SERIES STANDARD B



•ORD. NO. DRAWERS
F DD 1075 51 04 5
 Cabinet with 5 normal extension drawers
 Dim. mm 564x726x850 h Central lock



•ORD. NO. DRAWERS
F DD 1075 52 04 6
 Cabinet with 6 normal extension drawers
 Dim. mm 564x726x850 h Central lock



•ORD. NO. DRAWERS
F DD 1075 53 04 7
 Cabinet with 7 normal extension drawers
 Dim. mm 564x726x850 h Central lock



•ORD. NO. DRAWERS
F DD 1075 54 04 8
 Cabinet with 8 normal extension drawers
 Dimensions mm 564x726x850 h
 Central lock

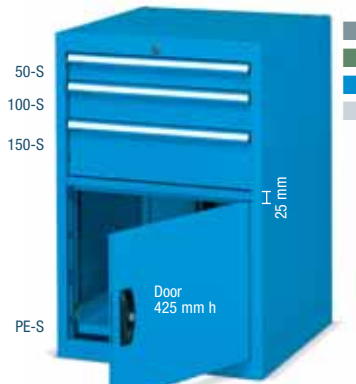

•ORD. NO. DRAWERS
F DD 1175 51 04 3
 Cabinet with 3 normal extension drawers
 1 normal retractable shelf
 Dim. mm 564x726x850 h Central lock

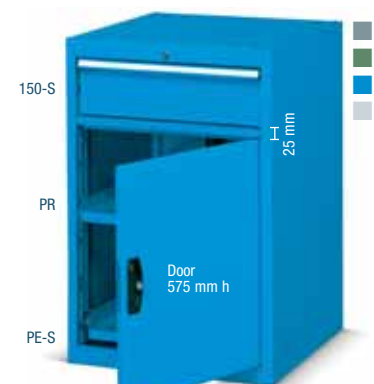

•ORD. NO. DRAWERS
F DD 1275 51 04 1
 Cabinet with 1 normal extension drawer
 1 adjustable shelf, 1 normal retractable shelf
 Dim. mm 564x726x850 h Central lock

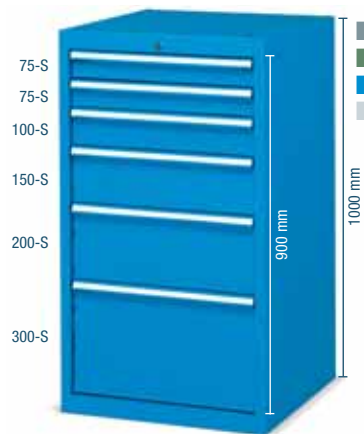

•ORD. NO. DRAWERS
F DD 1090 52 04 6
 Cabinet with 6 normal extension drawers
 Dimensions mm 564x726x1000 h
 Central lock



•ORD. NO. DRAWERS
F DD 1090 51 04 7
 Cabinet with 7 normal extension drawers
 Dimensions mm 564x726x1000 h
 Central lock

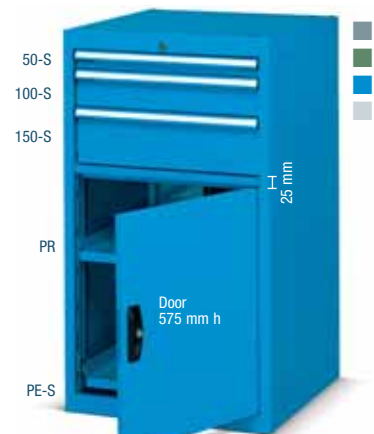

•ORD. NO. DRAWERS
F DD 1290 51 04 3
 Cabinet with 3 normal extension drawers
 1 adjustable shelf, 1 normal retractable shelf
 Dim. mm 564x726x1000 h Central lock

KEY

- RAL 7000 F.01
- RAL 6011 F.02
- RAL 5012 F.04
- RAL 7035 F.08



- The cabinets must be secured to the floor or to the wall.
- PE-S = normal retractable shelf (87%)
- PR = height adjustable shelf
- S = normal extension (87%)



■ Detail of the normal retractable shelves (PE-S) with load capacity of 70 kg.

■ Partitioning material: see page A72-A73

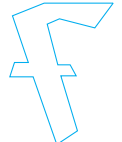

CABINETS SERIES STANDARD B



■ RAL 7000 + ■ RAL 7035

EXAMPLE INCLUDING:**ORD. NO.****F DD ZA01 00 EF**3 cabinets with drawers, doors,
adjustable shelves, retractable shelves,
Mdf top with rubber covering**Dimensions mm 1695x726x1030 h**

Tools and partitioning material excluded

ORD. NO. F BL 1020 00 00

Steel vice 130 mm

**ORD. NO. F DD E550 S1 08**

■ RAL 7035

ORD. NO. F DD E030 02 08

■ RAL 7035

EXAMPLE INCLUDING:**WORKSTATION****ORD. NO.****F BI A370 01 08**Workstation complete with 2 legs
40 mm thick multiplex worktop**Dimensions mm 2000x800x840 h****CABINET WITH WHEELS****ORD. NO.****F DD E550 S1 08**Complete with 4 drawers with single lock
3 security shelves**Dimensions mm 575x815x797 h****CABINET WITH WHEELS****ORD. NO.****F DD E030 02 08**

Complete with 3 drawers

Dimensions mm 575x815x772 h

Partitioning material excluded

RAL 7000 F... ..01

RAL 6011 F... ..02

RAL 5012 F... ..04

RAL 7035 F... ..08

INFO ■■ Partitioning
material: see
page A72-A73■ The handles can be
fitted towards the
bottom thereby
reducing the height
by 38 mm.www.famispa.com

LENGTH = 564 mm DEPTH = 726 mm (27x36 Eh)

CABINETS SERIES STANDARD B



| ORD. NO. | DRAWERS |
|---|--------------|
| F DD D020 01 04 | 2 |
| Cabinet with 2 normal extension drawers | |
| Ø100 mm standard rubber wheels | |
| Cabinet load capacity: 160 kg | |
| Dim. mm 575x815x810 h | |
| | Central lock |



| ORD. NO. | DRAWERS |
|---|--------------|
| F DD D020 02 04 | 2 |
| Cabinet with 2 normal extension drawers | |
| Ø100 mm standard rubber wheels | |
| Cabinet load capacity: 160 kg | |
| Dim. mm 575x815x810 h | |
| | Central lock |



| ORD. NO. | DRAWERS |
|---|--------------|
| F DD D020 03 04 | 3 |
| Cabinet with 3 normal extension drawers | |
| Ø100 mm standard rubber wheels | |
| Cabinet load capacity: 160 kg | |
| Dim. mm 575x815x810 h | |
| | Central lock |



| ORD. NO. | DRAWERS |
|---|--------------|
| F DD E030 01 04 | 2 |
| Cabinet with 2 normal extension drawers | |
| Ø100 mm nylon wheels | |
| Cabinet load capacity: 310 kg | |
| Dim. mm 575x815x810 h | |
| | Central lock |



| ORD. NO. | DRAWERS |
|---|--------------|
| F DD E030 02 04 | 3 |
| Cabinet with 3 normal extension drawers | |
| Ø100 mm nylon wheels | |
| Cabinet load capacity: 310 kg | |
| Dim. mm 575x815x810 h | |
| | Central lock |



| ORD. NO. | DRAWERS |
|---|--------------|
| F DD E030 04 04 | 4 |
| Cabinet with 4 normal extension drawers | |
| Ø100 mm nylon wheels | |
| Cabinet load capacity: 310 kg | |
| Dim. mm 575x815x810 h | |
| | Central lock |



| ORD. NO. | DRAWERS |
|---|--------------|
| F DD E550 01 04 | 3 |
| Cabinet with 3 normal extension drawers | |
| Ø100 mm nylon wheels. Cabinet load capacity: 310 kg | |
| Dim. mm 575x815x797 h | |
| | Central lock |



| ORD. NO. | DRAWERS |
|---|--------------|
| F DD E550 02 04 | 4 |
| Cabinet with 4 normal extension drawers | |
| Ø100 mm nylon wheels. Cabinet load capacity: 310 kg | |
| Dim. mm 575x815x797 h | |
| | Central lock |



| ORD. NO. | DRAWERS |
|---|--------------|
| F DD E550 03 04 | 5 |
| Cabinet with 5 normal extension drawers | |
| Ø100 mm nylon wheels. Cabinet load capacity: 310 kg | |
| Dim. mm 575x815x797 h | |
| | Central lock |

KEY

RAL 7000 F... ..01 RAL 6011 F... ..02 RAL 5012 F... ..04 RAL 7035 F... ..08



- S = normal extension (87%)
- All indicated loads are net and refer to evenly distributed weights.



■ The handles can be fitted towards the bottom thereby reducing the height by 38 mm.

■ Partitioning material: see page A72-A73



CABINETS SERIES STANDARD B



| • ORD. NO. | DRAWERS |
|---|----------|
| F DD E560 04 04 | 4 |
| Cabinet with 4 normal extension drawers | |
| Ø 100 mm nylon wheels | |
| Cabinet load capacity: 310 kg | |
| Dimensions mm 575x815x897 h | |
| Central lock | |



| • ORD. NO. | DRAWERS |
|---|----------|
| F DD E560 01 04 | 5 |
| Cabinet with 5 normal extension drawers | |
| Ø 100 mm nylon wheels | |
| Cabinet load capacity: 310 kg | |
| Dimensions mm 575x815x897 h | |
| Central lock | |



| • ORD. NO. | DRAWERS |
|---|----------|
| F DD E560 02 04 | 6 |
| Cabinet with 5 normal extension drawers | |
| Ø 100 mm nylon wheels | |
| Cabinet load capacity: 310 kg | |
| Dimensions mm 575x815x897 h | |
| Central lock | |



| • ORD. NO. | DRAWERS |
|---|----------|
| F DD E570 01 04 | 5 |
| Cabinet with 5 normal extension drawers | |
| Ø 100 mm nylon wheels | |
| Cabinet load capacity: 310 kg | |
| Dimensions mm 575x815x997 h | |
| Central lock | |



| • ORD. NO. | DRAWERS |
|---|----------|
| F DD E570 02 04 | 6 |
| Cabinet with 6 normal extension drawers | |
| Ø 100 mm nylon wheels | |
| Cabinet load capacity: 310 kg | |
| Dimensions mm 575x815x997 h | |
| Central lock | |



| • ORD. NO. | DRAWERS |
|---|----------|
| F DD E570 03 04 | 7 |
| Cabinet with 7 normal extension drawers | |
| Ø 100 mm nylon wheels | |
| Cabinet load capacity: 310 kg | |
| Dimensions mm 575x815x997 h | |
| Central lock | |

RAL 7000 F... ..01 RAL 6011 F... ..02 RAL 5012 F... ..04 RAL 7035 F... ..08

KEY ■

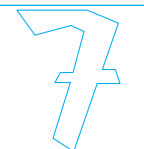

■ Partitioning material: see page A72-A73

■ The handles can be fitted towards the bottom thereby reducing the height by 38 mm.



- S = normal extension (87%)
- All indicated loads are net and refer to evenly distributed weights.



LENGTH = 564 mm DEPTH = 726 mm (27x36 Eh)

CABINETS SERIES STANDARD B



| •ORD. NO. | DRAWERS |
|---|----------|
| F DD E575 01 04 | 5 |
| Cabinet with 5 normal extension drawers | |
| Ø 100 mm nylon wheels | |
| Cabinet load capacity: 310 kg | |
| Dimensions mm 575x815x1047 h | |
| Central lock | |



| •ORD. NO. | DRAWERS |
|---|----------|
| F DD E575 02 04 | 6 |
| Cabinet with 6 normal extension drawers | |
| Ø 100 mm nylon wheels | |
| Cabinet load capacity: 310 kg | |
| Dimensions mm 575x815x1047 h | |
| Central lock | |



| ORD. NO. | DRAWERS |
|---|----------|
| F DD E575 03 04 | 7 |
| Cabinet with 7 normal extension drawers | |
| Ø 100 mm nylon wheels | |
| Cabinet load capacity: 310 kg | |
| Dimensions mm 575x815x1047 h | |
| Central lock | |



| •ORD. NO. | DRAWERS |
|---|----------|
| F DD E590 01 04 | 6 |
| Cabinet with 6 normal extension drawers | |
| Ø 100 mm nylon wheels | |
| Cabinet load capacity: 310 kg | |
| Dimensions mm 575x815x1197 h | |
| Central lock | |



| •ORD. NO. | DRAWERS |
|---|----------|
| F DD E590 02 04 | 7 |
| Cabinet with 7 normal extension drawers | |
| Ø 100 mm nylon wheels | |
| Cabinet load capacity: 310 kg | |
| Dimensions mm 575x815x1197 h | |
| Central lock | |



| •ORD. NO. | DRAWERS |
|---|----------|
| F DD E590 03 04 | 8 |
| Cabinet with 8 normal extension drawers | |
| Ø 100 mm nylon wheels | |
| Cabinet load capacity: 310 kg | |
| Dimensions mm 575x815x1197 h | |
| Central lock | |

KEY

RAL 7000 F... ..01 RAL 6011 F... ..02 RAL 5012 F... ..04 RAL 7035 F... ..08



- S = normal extension (87%)
- All indicated loads are net and refer to evenly distributed weights.



■ The handles can be fitted towards the bottom thereby reducing the height by 38 mm.

■ Partitioning material: see page A72-A73



CABINETS SERIES STANDARD B

EMPTY CABINETS PREPARED FOR DRAWERS

| ORD. NO. | USABLE HEIGHT mm | LOAD CAPACITY kg | DIMENSIONS mm |
|-----------------|------------------|------------------|----------------|
| F DD 1020 00 04 | 200 | 3100 | 564x726x283 h |
| F DD 1030 00 04 | 300 | 3100 | 564x726x383 h |
| F DD 1050 00 04 | 500 | 3100 | 564x726x600 h |
| F DD 1060 00 04 | 600 | 3100 | 564x726x700 h |
| F DD 1070 00 04 | 700 | 3100 | 564x726x800 h |
| F DD 1072 00 04 | 725 | 3100 | 564x726x825 h |
| F DD 1075 00 04 | 750 | 3100 | 564x726x850 h |
| F DD 1090 00 04 | 900 | 3100 | 564x726x1000 h |



■ 01 ■ 02 ■ 04 ■ 08

■ The cabinets must be secured to the floor or to the wall. If the cabinets are stacked they must be secured to the wall and their load capacity must be divided by 2. Further information for fixing set see page A60.

EMPTY CABINET WITH DOOR – DOOR WITH RIGHT-HAND OPENING

| ORD. NO. | DOOR HEIGHT mm | USABLE HEIGHT mm | LOAD CAPACITY kg | DIMENSIONS mm |
|-----------------|----------------|------------------|------------------|---------------|
| F DD 1260 D0 04 | 600 | 600 | 3100 | 564x726x700 h |

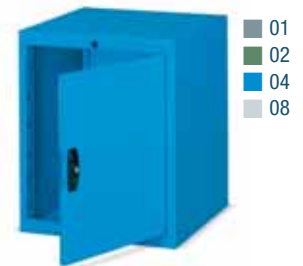

■ 01
■ 02
■ 04
■ 08

EMPTY CABINET WITH DOOR – DOOR WITH LEFT-HAND OPENING

| ORD. NO. | DOOR HEIGHT mm | USABLE HEIGHT mm | LOAD CAPACITY kg | DIMENSIONS mm |
|-----------------|----------------|------------------|------------------|---------------|
| F DD 1261 D0 04 | 600 | 600 | 3100 | 564x726x700 h |

■ Drawers cannot be fitted behind doors

EMPTY CABINETS PREPARED FOR DOORS

| ORD. NO. | DOOR HEIGHT (A) mm | DRAWERS HEIGHT (B) mm | USABLE HEIGHT (C) mm | LOAD CAPACITY kg | DIMENSIONS mm |
|-----------------|--------------------|-----------------------|----------------------|------------------|----------------|
| F DD 1150 00 04 | 400 | 75 | 500 | 3100 | 564x726x600 h |
| | 400 | 175 | | | |
| F DD 1160 00 04 | 425 | 150 | 600 | 3100 | 564x726x700 h |
| | 500 | 75 | | | |
| | 400 | 275 | | | |
| F DD 1170 00 04 | 425 | 250 | 700 | 3100 | 564x726x800 h |
| | 500 | 175 | | | |
| | 575 | 100 | | | |
| | 600 | 75 | | | |
| F DD 1172 00 04 | 400 | 300 | 725 | 3100 | 564x726x825 h |
| | 425 | 275 | | | |
| | 500 | 200 | | | |
| | 575 | 125 | | | |
| F DD 1175 00 04 | 600 | 100 | 750 | 3100 | 564x726x850 h |
| | 400 | 325 | | | |
| | 425 | 300 | | | |
| | 500 | 225 | | | |
| F DD 1190 00 04 | 575 | 150 | 900 | 3100 | 564x726x1000 h |
| | 600 | 125 | | | |
| | 400 | 475 | | | |
| | 425 | 450 | | | |
| | 500 | 375 | | | |
| | 575 | 300 | | | |
| | 600 | 275 | | | |

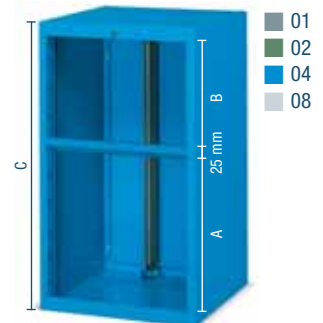

■ 01
■ 02
■ 04
■ 08

■ Drawers cannot be fitted behind doors

REVERSIBLE DOOR

| ORD. NO. | HEIGHT (A) mm |
|-----------------|---------------|
| F DD 9640 01 04 | 400 |
| F DD 9642 01 04 | 425 |
| F DD 9645 01 04 | 500 |
| F DD 9649 01 04 | 575 |
| F DD 9650 01 04 | 600 |



■ Drawers cannot be fitted behind doors

■ The door can be fitted both with left-hand and right-hand opening.

■ 01 ■ 02 ■ 04 ■ 08

SPARE LOCK AND SPARE HANDLE

| ORD. NO. |
|-------------------------------|
| R CSR 0003 00 |
| Spare lock (for cabinet) |
| R CSR 0035 00 |
| Spare lock (for doors handle) |
| R XDA 0002 07 |
| Spare handle (for doors) |

LENGTH = 564 mm DEPTH = 726 mm (27x36 Eh)

CABINETS SERIES STANDARD B

CABINET TO CABINET
FIXING

■ The article includes:
4 M8 nuts and bolts

ORD. NO. F AG 9202 00 99

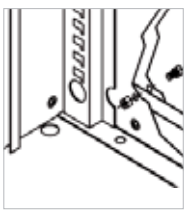

TWO SIDED ADHESIVE TAPE

ORD. NO.

R CMV 0025 00

width 15 mm, length 50 metres



■ 07

CABINET UPSTAND

ORD. NO.

DIMENSIONS mm

F DD 9150 01 07

564x726x20 h

oil-resistant rubber cover top with 3 edges

DRAWERS

ORD. NO.

FRONT HEIGHT mm

LOAD CAPACITY kg

USABLE DIMENSIONS mm

| | | | |
|-----------------|-----|-----|---------------|
| F DD 8050 00 04 | 50 | 60 | 447x600x36 h |
| F DD 8075 00 04 | 75 | 80 | 447x600x61 h |
| F DD 8100 00 04 | 100 | 100 | 447x600x86 h |
| F DD 8125 00 04 | 125 | 100 | 447x600x111 h |
| F DD 8150 00 04 | 150 | 100 | 447x600x136 h |
| F DD 8200 00 04 | 200 | 100 | 447x600x186 h |
| F DD 8250 00 04 | 250 | 100 | 447x600x236 h |
| F DD 8300 00 04 | 300 | 100 | 447x600x286 h |

Normal extension (87%)



■ 01
■ 02
■ 04
■ 08

■ Drawers cannot be fitted behind doors

■ Partitioning material:
see page A72



RETRACTABLE SHELVES

ORD. NO.

SIDE HEIGHT mm

LOAD CAPACITY kg

USABLE DIMENSIONS mm

| | | | |
|-----------------|---|----|---------|
| F DD 8000 00 04 | - | 70 | 435x610 |
|-----------------|---|----|---------|

Normal extension (87%)



■ 01
■ 02
■ 04

ADJUSTABLE SHELVES

ORD. NO.

SIDE HEIGHT mm

LOAD CAPACITY kg

USABLE DIMENSIONS mm

| | | | |
|-----------------|---|----|---------|
| F DD 9100 01 04 | - | 70 | 500x600 |
|-----------------|---|----|---------|

Without extension system

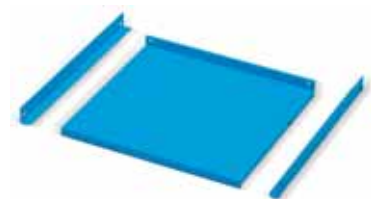

■ 01
■ 02
■ 04

PLINTHS

ORD. NO.

HEIGHT mm

F DD 9300 00 07

50

F DD 9330 00 07

100



■ 07

■ KEY

RAL 7000 F... ..01

RAL 6011 F... ..02

RAL 5012 F... ..04

RAL 7035 F... ..08



■ All indicated loads are net and refer to evenly distributed weights.

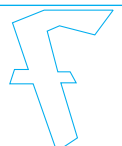

LENGTH = 564 mm DEPTH = 726 mm (27x36 Eh)

CABINETS SERIES STANDARD B

UPPER MDF TOP WITH RUBBER COVERING DIMENSIONS 565x726x31,5 mm H

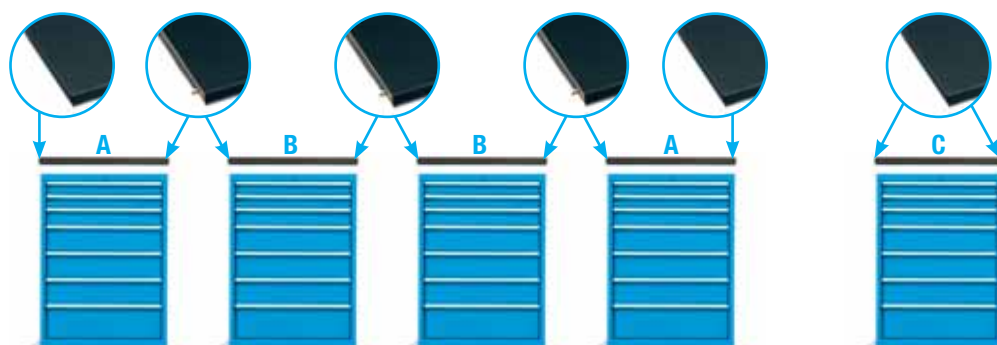

Detail of the oil-resistant rubber

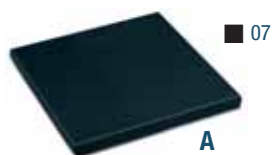

A

■ 07

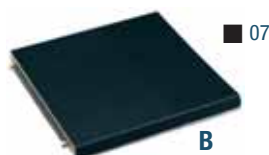

B

■ 07



C

■ 07

ORD. NO.

F UZ 3200 11 07

MDF top with rubber covering

Side profile

For end cabinets

Oil-resistant rubber mat

ORD. NO.

F UZ 3200 12 07

MDF top with rubber covering

No side profile

For additional central cabinets Oil-resist. rubber mat

ORD. NO.

F UZ 3200 13 07

MDF top with rubber covering

2 side profiles

For single cabinet

Oil-resistant rubber mat



RAL 7000 F... ..01

RAL 6011 F... ..02

RAL 5012 F... ..04

RAL 7035 F... ..08

KEY ■



■ The handles can be fitted towards the bottom thereby reducing the height by 38 mm.



■ All indicated loads are net and refer to evenly distributed weights.



LENGTH = 564 mm DEPTH = 726 mm (27x36 Eh)

CABINETS SERIES STANDARD B

CABINETS PREPARED FOR WHEELS

Cabinet prepared for wheels including: wheel plate, 4 edged top with oil-resistant rubber, 2 steel handles covered with shock-resistant rubber, cylinder lock with 2 keys, anti-tilt rod.

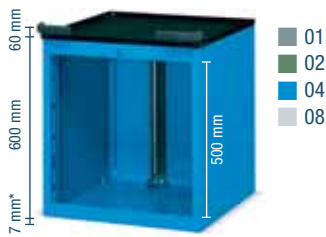

01
02
04
08

ORD. NO.

F DD 0550 00 04

Overall dim. mm 575x815x667 h without wheels

*Wheel plate thickness

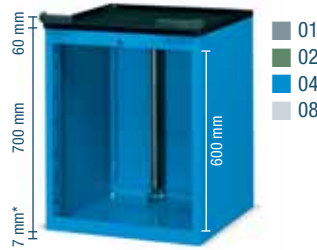

01
02
04
08

ORD. NO.

F DD 0560 00 04

Overall dim. mm 575x815x767 h without wheels

*Wheel plate thickness

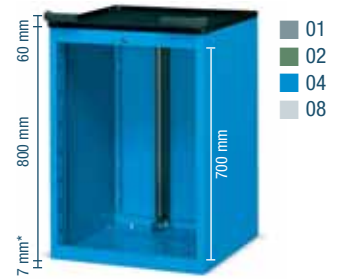

01
02
04
08

ORD. NO.

F DD 0570 00 04

Overall dim. mm 575x815x867 h without wheels

*Wheel plate thickness

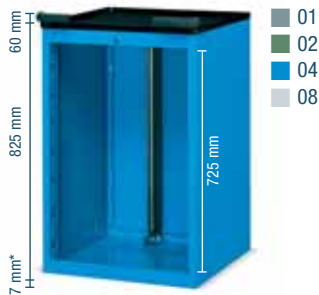

01
02
04
08

ORD. NO.

F DD 0572 00 04

Overall dim. mm 575x815x892 h without wheels

*Wheel plate thickness

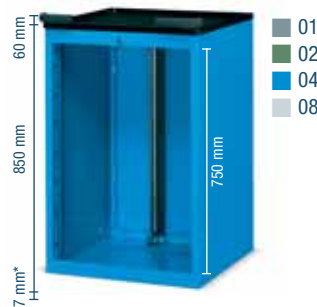

01
02
04
08

ORD. NO.

F DD 0575 00 04

Overall dim. mm 575x815x917 h without wheels

*Wheel plate thickness

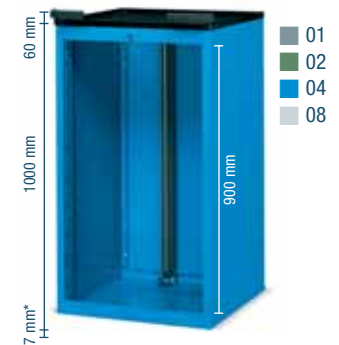

01
02
04
08

ORD. NO.

F DD 0590 00 04

Overall dim. mm 575x815x1067 h without wheels

*Wheel plate thickness



01
02
04
08

ORD. NO.

F DD 0020 00 04

Overall dim. mm 575x815x675 h without wheels

Prepared for wheels Ø mm 100 125 150



01
02
04
08

ORD. NO.

F DD 0030 00 04

Overall dim. mm 575x815x675 h without wheels

Prepared for wheels Ø mm 100 125 150



The single drawer opening system
ORD. NO. F DD 9400 00 07 must be
applied to all drawers of mobile
cabinets.

Other types of wheels see page A52

| C | SWIVEL WHEEL WITH BRAKE IN STANDARD RUBBER | | | |
|---|--|------|-----------------------|------|
| | ORD. NO. | Ø mm | CABINET LOAD CAPACITY | C mm |
| | C RG DAC11 100 | 100 | 160 kg | 130 |
| | C RG DAC12 125 | 125 | 235 kg | 160 |
| | C RG DAC13 150 | 150 | 280 kg | 185 |

| C | FIXED WHEEL IN STANDARD RUBBER | | | |
|---|--------------------------------|------|-----------------------|------|
| | ORD. NO. | Ø mm | CABINET LOAD CAPACITY | C mm |
| | C RG BAC11 100 | 100 | 160 kg | 130 |
| | C RG BAC12 125 | 125 | 235 kg | 160 |
| | C RG BAC13 150 | 150 | 280 kg | 185 |

| C | SWIVEL WHEEL WITH BRAKE IN NYLON | | | |
|---|----------------------------------|------|-----------------------|------|
| | ORD. NO. | Ø mm | CABINET LOAD CAPACITY | C mm |
| | C RN DAD10 100 | 100 | 310 kg | 130 |
| | C RN DAD11 125 | 125 | 475 kg | 160 |

| C | FIXED WHEEL IN NYLON | | | |
|---|-----------------------|------|-----------------------|------|
| | ORD. NO. | Ø mm | CABINET LOAD CAPACITY | C mm |
| | C RN BAD10 100 | 100 | 310 kg | 130 |
| | C RN BAD11 125 | 125 | 475 kg | 160 |

CABINETS SERIES STANDARD B

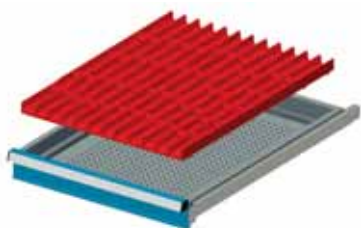

ORD. NO. FOR FRONT HEIGHTS

F FH 8605 01 00 50-300

Set including:

| | |
|---------------------|-----------|
| 12 Troughs | 4 grooves |
| 50 Plain partitions | 36 mm |

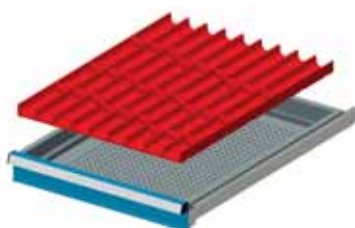

ORD. NO. FOR FRONT HEIGHTS

F FH 8605 06 00 50-300

Set including:

| | |
|---------------------|-----------|
| 12 Troughs | 3 grooves |
| 27 Plain partitions | 47 mm |

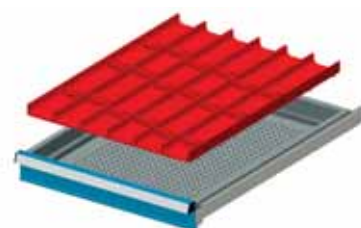

ORD. NO. FOR FRONT HEIGHTS

F FH 8605 04 00 50-300

Set including:

| | |
|---------------------|-----------|
| 12 Troughs | 2 grooves |
| 18 Plain partitions | 73 mm |

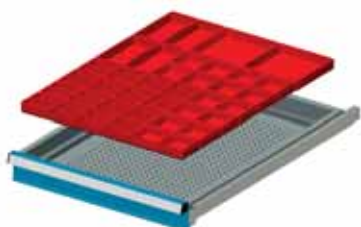

ORD. NO. FOR FRONT HEIGHTS

F FH 8605 16 00 50

F FH 8607 16 00 75

Set including:

| | |
|--------------------------------------|------------|
| 16 Plastic boxes with 2 compartments | 75x75 mm |
| 16 Plastic boxes | 75x75 mm |
| 4 Plastic boxes | 150x75 mm |
| 2 Plastic boxes | 150x150 mm |

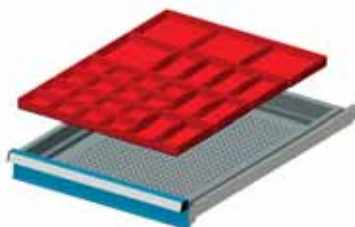

ORD. NO. FOR FRONT HEIGHTS

F FH 8605 17 00 50

F FH 8607 17 00 75

Set including:

| | |
|------------------|------------|
| 16 Plastic boxes | 75x75 mm |
| 8 Plastic boxes | 150x75 mm |
| 4 Plastic boxes | 150x150 mm |

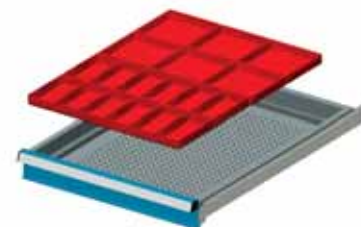

ORD. NO. FOR FRONT HEIGHTS

F FH 8605 18 00 50

F FH 8607 18 00 75

F FH 8610 18 00 100-125

Set including:

| | |
|------------------|------------|
| 12 Plastic boxes | 150x75 mm |
| 6 Plastic boxes | 150x150 mm |

INFO ■



■ Partitioning material: see page **A180**

www.famispa.com



LENGTH = 564 mm DEPTH = 726 mm (27x36 Eh)

CABINETS SERIES STANDARD B



| ORD. NO. | FOR FRONT HEIGHTS |
|------------------------|-------------------|
| F FH 8605 07 00 | 50 |
| F FH 8607 07 00 | 75 |
| F FH 8610 07 00 | 100-125 |
| F FH 8615 07 00 | 150-175 |
| F FH 8620 07 00 | 200-250 |
| F FH 8630 07 00 | 300 |
| Set including: | |
| 1 Slotted partition | 610 mm |
| 1 Plain partition | 200 mm |
| 1 Plain partition | 251 mm |

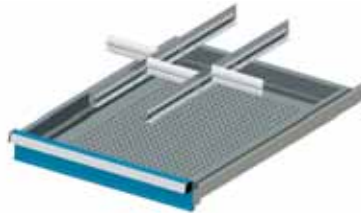

| ORD. NO. | FOR FRONT HEIGHTS |
|------------------------|-------------------|
| F FH 8605 08 00 | 50 |
| F FH 8607 08 00 | 75 |
| F FH 8610 08 00 | 100-125 |
| F FH 8615 08 00 | 150-175 |
| F FH 8620 08 00 | 200-250 |
| F FH 8630 08 00 | 300 |
| Set including: | |
| 2 Slotted partitions | 610 mm |
| 3 Plain partitions | 149 mm |



| ORD. NO. | FOR FRONT HEIGHTS |
|------------------------|-------------------|
| F FH 8605 09 00 | 50 |
| F FH 8607 09 00 | 75 |
| F FH 8610 09 00 | 100-125 |
| F FH 8615 09 00 | 150-175 |
| F FH 8620 09 00 | 200-250 |
| Set including: | |
| 2 Slotted partitions | 610 mm |
| 10 Plain partitions | 149 mm |

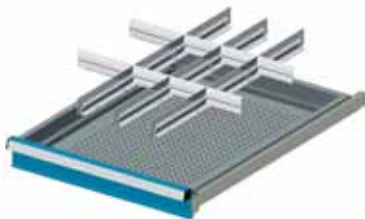

| ORD. NO. | FOR FRONT HEIGHTS |
|------------------------|-------------------|
| F FH 8605 10 00 | 50 |
| F FH 8607 10 00 | 75 |
| F FH 8610 10 00 | 100-125 |
| F FH 8615 10 00 | 150-175 |
| Set including: | |
| 3 Slotted partitions | 610 mm |
| 6 Plain partitions | 98 mm |
| 2 Plain partitions | 149 mm |

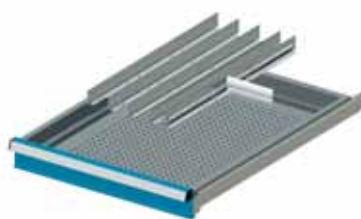

| ORD. NO. | FOR FRONT HEIGHTS |
|------------------------|-------------------|
| F FH 8605 12 00 | 50 |
| F FH 8607 12 00 | 75 |
| F FH 8610 12 00 | 100-125 |
| F FH 8615 12 00 | 150-175 |
| F FH 8620 12 00 | 200-250 |
| Set including: | |
| 1 Slotted partition | 610 mm |
| 4 Plain partitions | 610 mm |
| 1 Plain partition | 149 mm |



| ORD. NO. | FOR FRONT HEIGHTS |
|------------------------|-------------------|
| F FH 8605 13 00 | 50 |
| F FH 8607 13 00 | 75 |
| F FH 8610 13 00 | 100-125 |
| F FH 8615 13 00 | 150-175 |
| F FH 8620 13 00 | 200-250 |
| F FH 8630 13 00 | 300 |
| Set including: | |
| 2 Plain partitions | 610 mm |

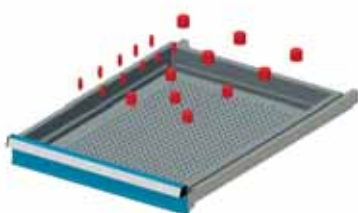

| ORD. NO. | FOR FRONT HEIGHTS |
|------------------------|-------------------|
| F FH 8605 15 00 | 50-300 |
| Set including: | |
| 10 Cutter holders | Ø 12,2 mm |
| 5 Cutter holders | Ø 26,5 mm |
| 5 Cutter holders | Ø 31,2 mm |

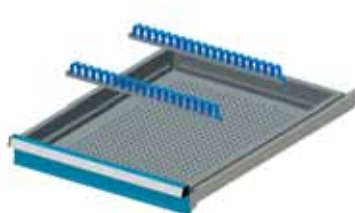

| ORD. NO. | FOR FRONT HEIGHTS |
|--------------------------|-------------------|
| F FH 8605 19 00 | 50-300 |
| Set including: | |
| 2 Multi-purpose supports | 440 mm |

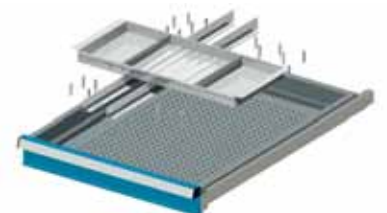

| ORD. NO. | FOR FRONT HEIGHTS |
|------------------------|-------------------|
| F FH 8610 14 00 | 100 |
| F FH 8615 14 00 | 150 |
| F FH 8620 14 00 | 200-250 |
| Set including: | |
| 2 Plain partitions | 610 mm |
| 20 Location pins | 27 mm |
| 1 Sliding drawer | 470 mm |

■ INFO

www.famispa.com

■ Partitioning material: see page A180





ORD. NO. F AG 1040 S1 51
RAL 5012+7000



ORD. NO. F AG L134 03 50
RAL 7035+5012

36 EH (600 mm)



27 EH (447 mm)

FLOOR FIXING SET



2x

- 2 "HILTI" plugs for concrete floors \geq to classes B25/RBK250/MPA 25 N/mm²
- Recommended traction of the plug: 2.9 KN
- Plug diameter: \varnothing 6 mm

ORD. NO. F AG 9204 00 99

CABINET FLOOR FIXING SET

- Pair of spare galvanised brackets
- \varnothing 6 mm hole



ORD. NO. F AG 9200 00 99

CABINET

ORD. NO.

F AG 1040 S1 51

Complete with 10 drawers,
1 rubber cover top with 4 edges

Dimensions mm 717x573x1000 h

Tools and partitioning material
excluded

CABINET WITH WHEELS

ORD. NO.

F AG L134 03 50

Complete with 8 drawers

Dimensions mm 717x574x1121 h

RAL 7000 F.01

RAL 6011 F.02

RAL 5012 F.04

RAL 7035 F.08

SUPPLEMENTARY PARTS ■



- Partitioning material: see page A80-A81



- **Spare key.** Always indicate the number on the cylinder lock of the key to be replaced.

ORD. NO. R CSC 0002 00

- **Master key.** This type of key opens all the 45 and 46 series locks.

ORD. NO. R CSC 0001 00



LENGTH = 717 mm DEPTH = 573 mm (36x27 Eh)

CABINETS SERIES STANDARD GE



■ The door can be closed by the edge of the lower drawer handle (ref. Y)

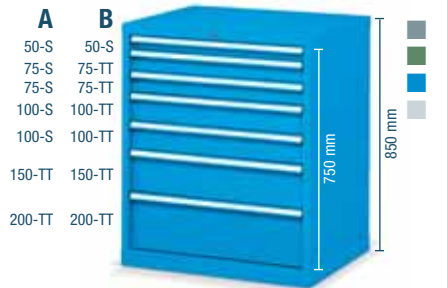

- | | |
|----------|----------|
| A | B |
| 50-S | 50-S |
| 75-S | 75-TT |
| 75-S | 75-TT |
| 100-S | 100-TT |
| 100-S | 100-TT |
| 150-TT | 150-TT |
| 200-TT | 200-TT |

| ORD. NO. | TYPE |
|------------------------|--------------|
| F AG 1034 01 04 | A |
| F AG 1034 51 04 | B |
| Cabinet with 7 drawers | |
| Dim. mm 717x573x850 h | Central lock |

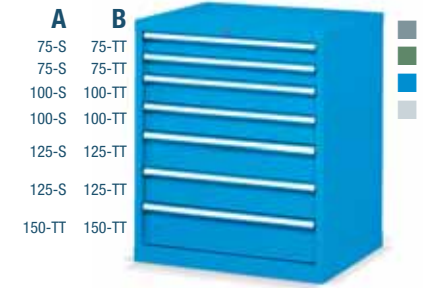

- | | |
|----------|----------|
| A | B |
| 75-S | 75-TT |
| 75-S | 75-TT |
| 100-S | 100-TT |
| 100-S | 100-TT |
| 125-S | 125-TT |
| 125-S | 125-TT |
| 150-TT | 150-TT |

| ORD. NO. | TYPE |
|------------------------|--------------|
| F AG 1034 02 04 | A |
| F AG 1034 52 04 | B |
| Cabinet with 7 drawers | |
| Dim. mm 717x573x850 h | Central lock |

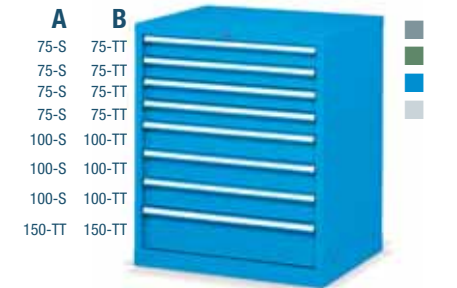

- | | |
|----------|----------|
| A | B |
| 75-S | 75-TT |
| 75-S | 75-TT |
| 75-S | 75-TT |
| 75-S | 75-TT |
| 100-S | 100-TT |
| 100-S | 100-TT |
| 100-S | 100-TT |
| 150-TT | 150-TT |

| ORD. NO. | TYPE |
|------------------------|--------------|
| F AG 1034 03 04 | A |
| F AG 1034 53 04 | B |
| Cabinet with 8 drawers | |
| Dim. mm 717x573x850 h | Central lock |

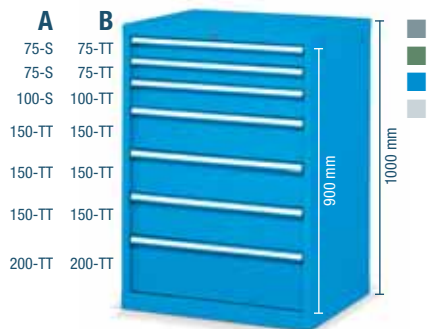

- | | |
|----------|----------|
| A | B |
| 75-S | 75-TT |
| 75-S | 75-TT |
| 100-S | 100-TT |
| 150-TT | 150-TT |
| 150-TT | 150-TT |
| 150-TT | 150-TT |
| 200-TT | 200-TT |

| ORD. NO. | TYPE |
|------------------------|--------------|
| F AG 1040 03 04 | A |
| F AG 1040 53 04 | B |
| Cabinet with 7 drawers | |
| Dim. mm 717x573x1000 h | Central lock |

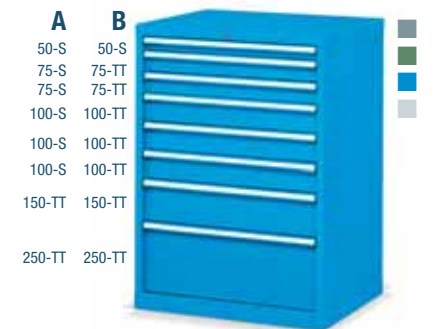

- | | |
|----------|----------|
| A | B |
| 50-S | 50-S |
| 75-S | 75-TT |
| 75-S | 75-TT |
| 100-S | 100-TT |
| 100-S | 100-TT |
| 100-S | 100-TT |
| 150-TT | 150-TT |
| 250-TT | 250-TT |

| ORD. NO. | TYPE |
|------------------------|--------------|
| F AG 1040 10 04 | A |
| F AG 1040 60 04 | B |
| Cabinet with 8 drawers | |
| Dim. mm 717x573x1000 h | Central lock |

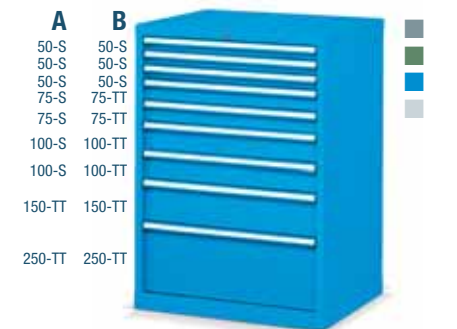

- | | |
|----------|----------|
| A | B |
| 50-S | 50-S |
| 50-S | 50-S |
| 50-S | 50-S |
| 75-S | 75-TT |
| 75-S | 75-TT |
| 100-S | 100-TT |
| 100-S | 100-TT |
| 150-TT | 150-TT |
| 250-TT | 250-TT |

| ORD. NO. | TYPE |
|------------------------|--------------|
| F AG 1040 05 04 | A |
| F AG 1040 55 04 | B |
| Cabinet with 9 drawers | |
| Dim. mm 717x573x1000 h | Central lock |

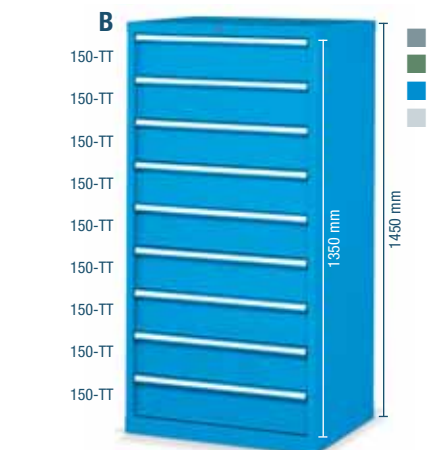

- | |
|----------|
| B |
| 150-TT |
| 150-TT |
| 150-TT |
| 150-TT |
| 150-TT |
| 150-TT |
| 150-TT |
| 150-TT |
| 150-TT |
| 150-TT |
| 150-TT |

| ORD. NO. | TYPE |
|------------------------|--------------|
| - | - |
| F AG 1058 01 04 | B |
| Cabinet with 9 drawers | |
| Dim. mm 717x573x1450 h | Central lock |

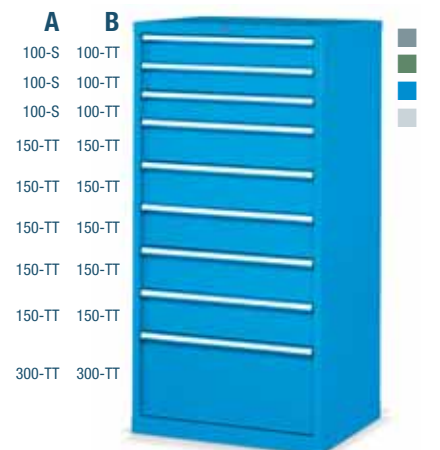

- | | |
|----------|----------|
| A | B |
| 100-S | 100-TT |
| 100-S | 100-TT |
| 100-S | 100-TT |
| 150-TT | 150-TT |
| 150-TT | 150-TT |
| 150-TT | 150-TT |
| 150-TT | 150-TT |
| 150-TT | 150-TT |
| 150-TT | 150-TT |
| 300-TT | 300-TT |

| ORD. NO. | TYPE |
|------------------------|--------------|
| F AG 1058 04 04 | A |
| F AG 1058 54 04 | B |
| Cabinet with 9 drawers | |
| Dim. mm 717x573x1450 h | Central lock |

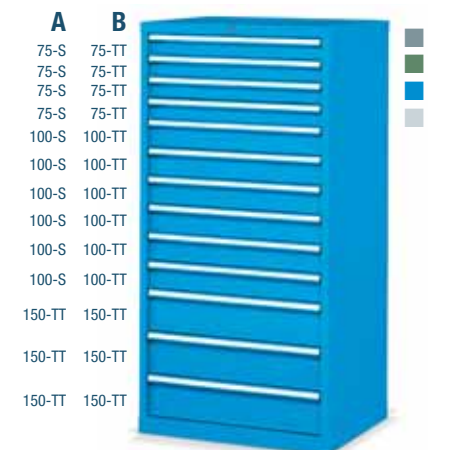

- | | |
|----------|----------|
| A | B |
| 75-S | 75-TT |
| 75-S | 75-TT |
| 75-S | 75-TT |
| 75-S | 75-TT |
| 100-S | 100-TT |
| 100-S | 100-TT |
| 100-S | 100-TT |
| 100-S | 100-TT |
| 100-S | 100-TT |
| 100-S | 100-TT |
| 150-TT | 150-TT |
| 150-TT | 150-TT |
| 150-TT | 150-TT |

| ORD. NO. | TYPE |
|-------------------------|--------------|
| F AG 1058 03 04 | A |
| F AG 1058 53 04 | B |
| Cabinet with 13 drawers | |
| Dim. mm 717x573x1450 h | Central lock |

CABINETS SERIES STANDARD GE



- | A | B |
|--------|--------|
| 75-S | 75-TT |
| 75-S | 75-TT |
| 100-S | 100-TT |
| 100-S | 100-TT |
| 125-S | 125-TT |
| 125-S | 125-TT |
| 150-TT | 150-TT |



- | A | B |
|--------|--------|
| 50-S | 50-S |
| 75-S | 75-TT |
| 75-S | 75-TT |
| 100-S | 100-TT |
| 100-S | 100-TT |
| 150-TT | 150-TT |
| 200-TT | 200-TT |



- | A | B |
|--------|--------|
| 75-S | 75-TT |
| 75-S | 75-TT |
| 75-S | 75-TT |
| 75-S | 75-TT |
| 100-S | 100-TT |
| 100-S | 100-TT |
| 100-S | 100-TT |
| 150-TT | 150-TT |

| ORD. NO. | TYPE |
|---|----------|
| F AG S134 02 04 | A |
| F AG S134 52 04 | B |
| Cabinet with 7 drawers with Ø 125 mm wheels in elastic rubber | |
| Cabinet load capacity: 420 kg | |
| Dimensions mm 717x574x1077 h | |
| Central lock | |

| ORD. NO. | TYPE |
|---|----------|
| F AG S134 01 04 | A |
| F AG S134 51 04 | B |
| Cabinet with 7 drawers with Ø 125 mm wheels in elastic rubber | |
| Cabinet load capacity: 420 kg | |
| Dimensions mm 717x574x1077 h | |
| Central lock | |

| ORD. NO. | TYPE |
|---|----------|
| F AG S134 03 04 | A |
| F AG S134 53 04 | B |
| Cabinet with 8 drawers with Ø 125 mm wheels in elastic rubber | |
| Cabinet load capacity: 420 kg | |
| Dimensions mm 717x574x1077 h | |
| Central lock | |

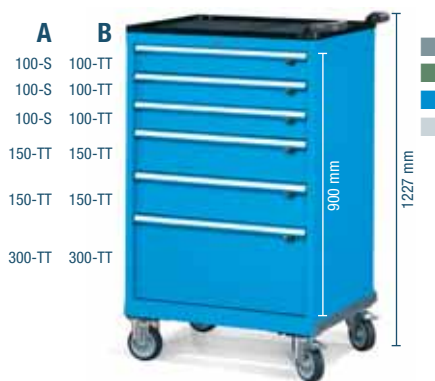

- | A | B |
|--------|--------|
| 100-S | 100-TT |
| 100-S | 100-TT |
| 100-S | 100-TT |
| 150-TT | 150-TT |
| 150-TT | 150-TT |
| 300-TT | 300-TT |



- | A | B |
|--------|--------|
| 75-S | 75-TT |
| 75-S | 75-TT |
| 100-S | 100-TT |
| 150-TT | 150-TT |
| 150-TT | 150-TT |
| 150-TT | 150-TT |
| 200-TT | 200-TT |



- | A | B |
|--------|--------|
| 50-S | 50-S |
| 75-S | 75-TT |
| 75-S | 75-TT |
| 100-S | 100-TT |
| 100-S | 100-TT |
| 150-TT | 150-TT |
| 150-TT | 150-TT |
| 200-TT | 200-TT |

| ORD. NO. | TYPE |
|---|----------|
| F AG S140 01 04 | A |
| F AG S140 51 04 | B |
| Cabinet with 6 drawers with Ø 125 mm wheels in elastic rubber | |
| Cabinet load capacity: 420 kg | |
| Dimensions mm 717x574x1227 h | |
| Central lock | |

| ORD. NO. | TYPE |
|---|----------|
| F AG S140 02 04 | A |
| F AG S140 52 04 | B |
| Cabinet with 6 drawers with Ø 125 mm wheels in elastic rubber | |
| Cabinet load capacity: 420 kg | |
| Dimensions mm 717x574x1227 h | |
| Central lock | |

| ORD. NO. | TYPE |
|---|----------|
| F AG S140 03 04 | A |
| F AG S140 53 04 | B |
| Cabinet with 8 drawers with Ø 125 mm wheels in elastic rubber | |
| Cabinet load capacity: 420 kg | |
| Dimensions mm 717x574x1227 h | |
| Central lock | |

- RAL 7000 F.01
- RAL 6011 F.02
- RAL 5012 F.04
- RAL 7035 F.08

KEY ■

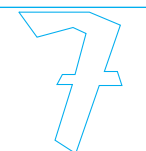

■ Partitioning material: see page A80-A81

■ The handles can be fitted towards the bottom thereby reducing the height by 38 mm.



- TT = telescopic full extension (100%)
- S = normal extension (87%)
- All indicated loads are net and refer to evenly distributed weights.



LENGTH = 717 mm DEPTH = 573 mm (36x27 Eh)

CABINETS SERIES STANDARD GE

FLAP DOOR

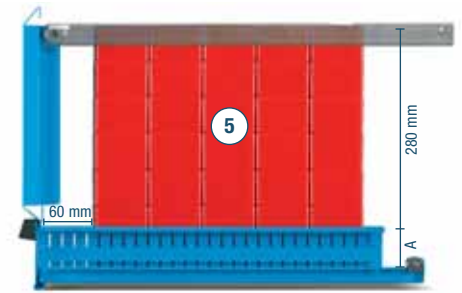
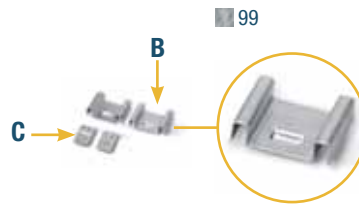
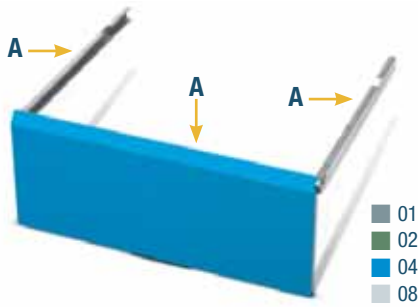

| ORD. NO. | REFERENCE |
|--|-----------|
| F AG 9510 00 04 | A+(Cx2) |
| Flap door with 2 guides and 2 brackets to block the door with the lower drawer locked. | |

| ORD. NO. | REFERENCE |
|--|-----------|
| F DA 9698 00 99 | B |
| The order number includes just 1 piece. 2 pieces are needed for each door. | |

A = usable height of the drawer
Warning: the 60 mm distance from the drawer edge should be respected only if the door has to be closed with the two brackets (Ref. C)



■ The two order number (ref. B) must be used when the door is fitted along with the normal or full telescopic extension drawer (ref. Z). See photo ref. 5 to understand the usable internal volume.

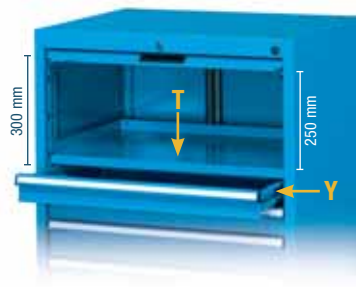

■ The two order number (ref. B) are not required when the door is fitted along with the adjustable shelf (ref. T) ORD. NO. F SR 1210 01 .. N. B. the drawer (ref. Y) must be normal extension.



■ The door can be closed by the edge of the lower drawer handle (ref. Y)

■ INFO

RAL 7000 F... ..01 RAL 6011 F... ..02 RAL 5012 F... ..04 RAL 7035 F... ..08



www.famispa.com

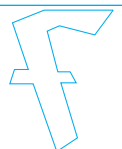

CABINETS SERIES STANDARD GE

EMPTY CABINETS

| ORD. NO. | USABLE HEIGHT mm | LOAD CAPACITY kg | DIMENSIONS mm |
|-----------------|------------------|------------------|----------------|
| F AG 1034 00 04 | 750 | 3100 | 717x573x850 h |
| F AG 1040 00 04 | 900 | 3100 | 717x573x1000 h |
| F AG 1058 00 04 | 1350 | 3100 | 717x573x1450 h |

■ 01 ■ 02 ■ 04 ■ 08



■ The cabinets must be secured to the floor or to the wall. If the cabinets are stacked they must be secured to the wall and their load capacity must be divided by 2. Further information for fixing set see page A60.

SPARE LOCK

ORD. NO. R CSR 0003 00
for cabinet

FULL TELESCOPIC EXTENSION DRAWERS (TT)

| ORD. NO. | FRONT HEIGHT mm | LOAD CAPACITY kg | USABLE DIMENSIONS mm |
|-----------------|-----------------|------------------|----------------------|
| F FG 1107 00 04 | 75 | 200 | 600x447x54 h |
| F FG 1110 00 04 | 100 | 200 | 600x447x79 h |
| F FG 1112 00 04 | 125 | 200 | 600x447x104 h |
| F FG 1115 00 04 | 150 | 200 | 600x447x129 h |
| F FG 1120 00 04 | 200 | 200 | 600x447x179 h |
| F FG 1125 00 04 | 250 | 200 | 600x447x229 h |
| F FG 1130 00 04 | 300 | 200 | 600x447x279 h |

Full telescopic extension (100%)



■ Partitioning material: see page A80-A81

NORMAL EXTENSION DRAWERS (S)

| ORD. NO. | FRONT HEIGHT mm | LOAD CAPACITY kg | USABLE DIMENSIONS mm |
|-----------------|-----------------|------------------|----------------------|
| F FG 1005 00 04 | 50 | 60 | 600x447x36 |
| F FG 1007 00 04 | 75 | 80 | 600x447x61 |
| F FG 1010 00 04 | 100 | 100 | 600x447x86 |
| F FG 1012 00 04 | 125 | 100 | 600x447x111 |

Normal extension (87%)



FULL TELESCOPIC EXTENSION SHELVES (PE-TT)

| ORD. NO. | SIDE HEIGHT mm | LOAD CAPACITY kg | USABLE DIMENSIONS mm |
|-----------------|----------------|------------------|----------------------|
| F FG 8110 00 04 | - | 200 | 610x459 |

Full telescopic extension (100%)



NORMAL EXTENSION SHELVES (PE-S)

| ORD. NO. | SIDE HEIGHT mm | LOAD CAPACITY kg | USABLE DIMENSIONS mm |
|-----------------|----------------|------------------|----------------------|
| F FG 8010 00 04 | - | 100 | 610x459 |

Normal extension (87%)



ADJUSTABLE SHELVES

| ORD. NO. | SIDE HEIGHT mm | LOAD CAPACITY kg | USABLE DIMENSIONS mm |
|-----------------|----------------|------------------|----------------------|
| F SR 1210 01 04 | 25 | 150 | 655x460 |

Without extension system



CABINET TO CABINET FIXING

■ The article includes:
4 M8 nuts and bolts

ORD. NO. F AG 9202 00 99

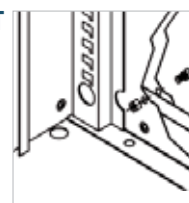

TWO SIDED ADHESIVE TAPE

ORD. NO.

R CMV 0025 00

width 15 mm, length 50 metres



CABINET UPSTAND

ORD. NO. DIMENSIONS mm

F AG 9000 01 07 717x573x20 h

oil-resistant rubber cover top with 3 edges

LENGTH = 717 mm DEPTH = 573 mm (36x27 Eh)

CABINETS SERIES STANDARD GE



PLINTHS

ORD. NO.

F RR 0050 00 07

Plinths height 50 mm



PLINTHS FOR TRANSPALLET

ORD. NO.

F RR 0300 00 07 Plinths height 100 mm

F RR 0405 00 07 Facing piece



PLINTHS FOR FORK LIFT TRUCK

ORD. NO.

F RR 0200 00 07 Pair of plinths height 60 mm

F RR 0400 00 07 Facing piece

UPPER MDF TOP WITH RUBBER COVERING DIMENSIONS 718x573x31,5 mm H

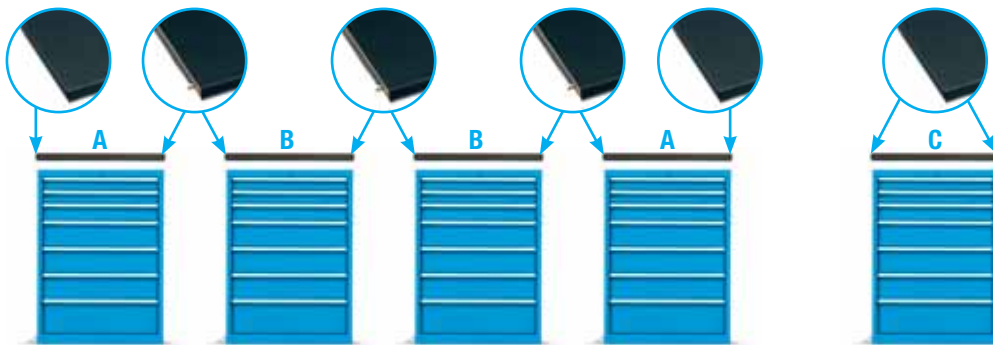

ORD. NO. F UZ 9999 00 00

Drilling of the cabinet upper shelf for the MDF top fixing.



Detail of the oil-resistant rubber

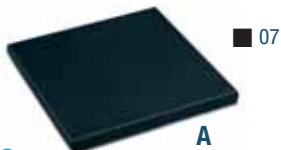

ORD. NO.

F UZ 3080 11 07

MDF top with rubber covering

Side profile

For end cabinets

Oil-resistant rubber mat

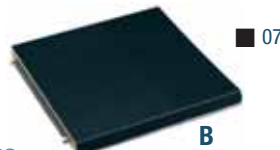

ORD. NO.

F UZ 3080 12 07

MDF top with rubber covering

No side profile

For additional central cabinets Oil-resist. rubber mat

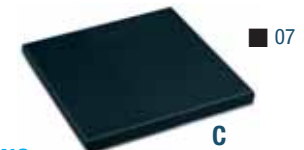

ORD. NO.

F UZ 3080 13 07

MDF top with rubber covering

2 side profiles

For single cabinet

Oil-resistant rubber mat

CABINET PREPARED FOR WHEELS

Cabinet prepared for wheels including: wheel plate, 4 edged top with oil-resistant rubber, 2 steel handles covered with shock-resistant rubber, cylinder lock with 2 keys, anti-tilt rod.



■ The single drawer opening system
ORD. NO. F DD 9400 00 07 must be applied to all drawers of mobile cabinets.

01
02
04
08

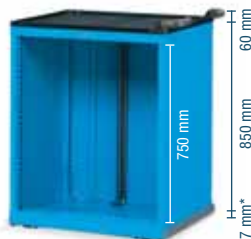

ORD. NO.

F AG 0134 00 04

Overall dim. mm 792x574x917 h without wheels

*Wheel plate thickness

01
02
04
08

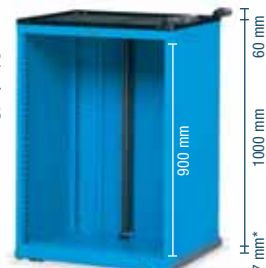

ORD. NO.

F AG 0140 00 04

Overall dim. mm 792x574x1067 h without wheels

*Wheel plate thickness

■ Other types of wheels: see page A52

| ELASTIC RUBBER SWIVEL WHEEL WITH BRAKE | ORD. NO. | Ø mm | CABINET LOAD CAPACITY | C mm |
|--|----------------|------|-----------------------|------|
| | C RG DCE15 125 | 125 | 420 kg | 160 |

| ELASTIC RUBBER FIXED WHEEL | ORD. NO. | Ø mm | CABINET LOAD CAPACITY | C mm |
|----------------------------|----------------|------|-----------------------|------|
| | C RG BCE15 125 | 125 | 420 kg | 160 |

| NYLON SWIVEL WHEEL WITH BRAKE | ORD. NO. | Ø mm | CABINET LOAD CAPACITY | C mm |
|-------------------------------|----------------|------|-----------------------|------|
| | C RN DAD10 100 | 100 | 255 kg | 130 |
| | C RN DAD11 125 | 125 | 420 kg | 160 |

| NYLON FIXED WHEEL | ORD. NO. | Ø mm | CABINET LOAD CAPACITY | C mm |
|-------------------|----------------|------|-----------------------|------|
| | C RN BAD10 100 | 100 | 255 kg | 130 |
| | C RN BAD11 125 | 125 | 420 kg | 160 |

CABINETS SERIES STANDARD GE

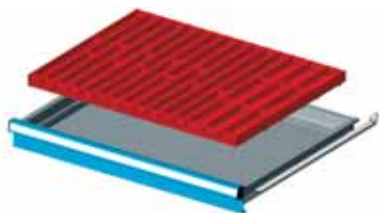
**ORD. NO.**

FOR FRONT HEIGHTS

F FH 1005 10 00

50-300

Set including:

| | |
|---------------------|-----------|
| 9 Troughs | 4 grooves |
| 36 Plain partitions | 36 mm |
| 3 Troughs | 3 grooves |
| 12 Plain partitions | 47 mm |

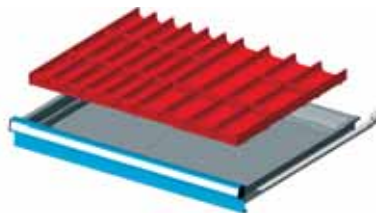
**ORD. NO.**

FOR FRONT HEIGHTS

F FH 1005 13 00

50-300

Set including:

| | |
|---------------------|-----------|
| 6 Troughs | 3 grooves |
| 18 Plain partitions | 47 mm |
| 6 Troughs | 2 grooves |
| 12 Plain partitions | 73 mm |

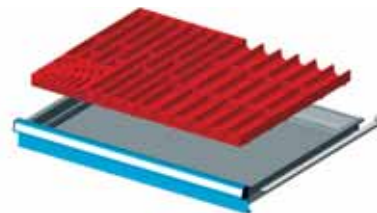
**ORD. NO.**

FOR FRONT HEIGHTS

F FH 1005 15 00

50-300

Set including:

| | |
|---------------------|------------|
| 5 Troughs | 4 grooves |
| 20 Plain partitions | 36 mm |
| 6 Troughs | 3 grooves |
| 20 Plain partitions | 47 mm |
| 1 Allen key tray | 150x150 mm |

**EXAMPLE INCLUDING:****ORD. NO.****F AG ZA01 00 01**

4 cabinets complete with drawers and retractable shelves

Dimensions mm 1435x573x1700 h

Tools and partitioning material excluded

■ RAL 7000

RAL 7000 F... ..01

RAL 6011 F... ..02

RAL 5012 F... ..04

RAL 7035 F... ..08

INFO ■

■ Partitioning material: see page **A180**

www.famispa.com



LENGTH = 717 mm DEPTH = 573 mm (36x27 Eh)

CABINETS SERIES STANDARD GE

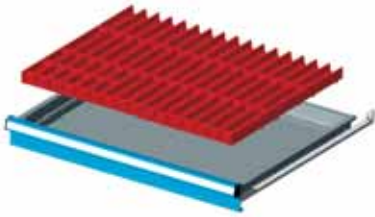

| ORD. NO. | FOR FRONT HEIGHTS |
|------------------------|-------------------|
| F FH 1005 21 00 | 50-300 |
| Set including: | |
| 12 Troughs | 4 grooves |
| 16 Plain partitions | 36 mm |

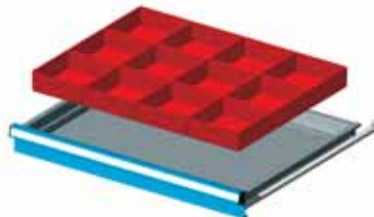

| ORD. NO. | FOR FRONT HEIGHTS |
|------------------------|-------------------|
| F FH 1005 09 00 | 50 |
| F FH 1007 09 00 | 75 |
| F FH 1010 09 00 | 100-125 |
| Set including: | |
| 12 Plastic boxes | 150x150 mm |

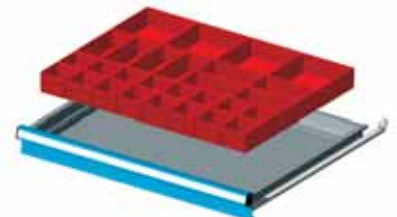

| ORD. NO. | FOR FRONT HEIGHTS |
|------------------------|-------------------|
| F FH 1005 18 00 | 50 |
| F FH 1007 18 00 | 75 |
| Set including: | |
| 16 Plastic boxes | 75x75 mm |
| 8 Plastic boxes | 150x75 mm |
| 4 Plastic boxes | 150x150 mm |

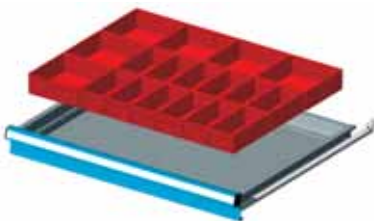

| ORD. NO. | FOR FRONT HEIGHTS |
|------------------------|-------------------|
| F FH 1005 16 00 | 50 |
| F FH 1007 16 00 | 75 |
| F FH 1010 16 00 | 100-125 |
| Set including: | |
| 12 Plastic boxes | 150x75 mm |
| 6 Plastic boxes | 150x150 mm |

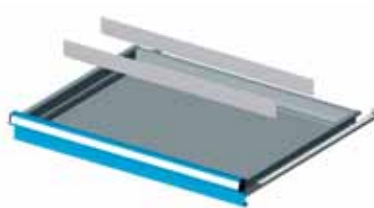

| ORD. NO. | FOR FRONT HEIGHTS |
|------------------------|-------------------|
| F FH 1005 01 00 | 50 |
| F FH 1007 01 00 | 75 |
| F FH 1010 01 00 | 100-125 |
| F FH 1015 01 00 | 150-175 |
| F FH 1020 01 00 | 200-250 |
| F FH 1030 01 00 | 300 |
| Set including: | |
| 2 Plain partitions | 610 mm |

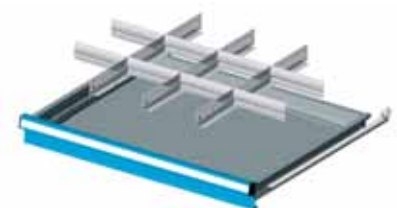

| ORD. NO. | FOR FRONT HEIGHTS |
|------------------------|-------------------|
| F FH 1005 03 00 | 50 |
| F FH 1007 03 00 | 75 |
| F FH 1010 03 00 | 100-125 |
| F FH 1015 03 00 | 150-175 |
| F FH 1020 03 00 | 200-250 |
| Set including: | |
| 3 Slotted partitions | 455 mm |
| 8 Plain partitions | 149 mm |

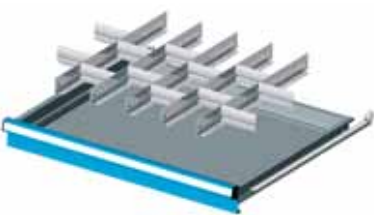

| ORD. NO. | FOR FRONT HEIGHTS |
|------------------------|-------------------|
| F FH 1005 06 00 | 50 |
| F FH 1007 06 00 | 75 |
| F FH 1010 06 00 | 100-125 |
| F FH 1015 06 00 | 150-175 |
| Set including: | |
| 5 Slotted partitions | 455 mm |
| 12 Plain partitions | 98 mm |

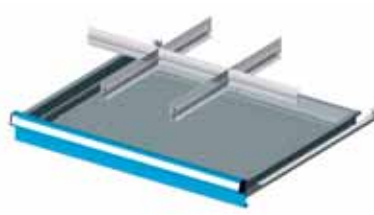

| ORD. NO. | FOR FRONT HEIGHTS |
|------------------------|-------------------|
| F FH 1005 05 00 | 50 |
| F FH 1007 05 00 | 75 |
| F FH 1010 05 00 | 100-125 |
| F FH 1015 05 00 | 150-175 |
| F FH 1020 05 00 | 200-250 |
| F FH 1030 05 00 | 300 |
| Set including: | |
| 2 Slotted partitions | 455 mm |
| 3 Plain partitions | 200 mm |

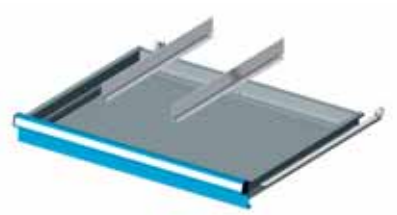

| ORD. NO. | FOR FRONT HEIGHTS |
|------------------------|-------------------|
| F FH 8405 13 00 | 50 |
| F FH 8407 13 00 | 75 |
| F FH 8410 13 00 | 100-125 |
| F FH 8415 13 00 | 150-175 |
| F FH 8420 13 00 | 200-250 |
| Set including: | |
| 2 Plain partitions | 455 mm |

■ INFO

www.famispa.com

■ Partitioning material: see page A180

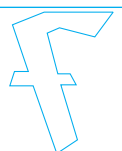



FLOOR FIXING SET



- 2 "HILTI" plugs for concrete floors \geq to classes B25/RBK250/MPa 25 N/mm²
- Recommended traction of the plug: 2.9 KN
- Plug diameter: \varnothing 6 mm

ORD. NO. F AG 9204 00 99

CABINET FLOOR FIXING SET

- Pair of spare galvanised brackets
- \varnothing 6 mm hole



ORD. NO. F AG 9200 00 99

CABINETS

ORD. NO.

F AG 2040 S1 56

Complete with 9 drawers,
1 rubber cover top with 3 edges

Dimensions mm 717x726x1020 h

Tools and partitioning material
excluded

CABINET WITH WHEELS

ORD. NO.

F AG L234 S1 50

Complete with 4 drawers,
1 adjustable shelf, 1 flap door,
1 rubber cover MDF top,
1 perforated back panel

Dim. mm 717x802x1091/1791 h

Hooks and tools excluded

RAL 7000 F.01

RAL 6011 F.02

RAL 5012 F.04

RAL 7035 F.08

SUPPLEMENTARY PARTS ■



- Partitioning material: see page A96



- **Spare key.** Always indicate the number on the cylinder lock of the key to be replaced.

ORD. NO. R CSC 0002 00

- **Master key.** This type of key opens all the 45 and 46 series locks.

ORD. NO. R CSC 0001 00



LENGTH = 717 mm DEPTH = 726 mm (36x36 Eh)

CABINETS SERIES STANDARD G



The door can be closed by the edge of the lower drawer handle (ref. Y)



A B
50-S 50-S
100-S 100-TT
150-S 150-TT

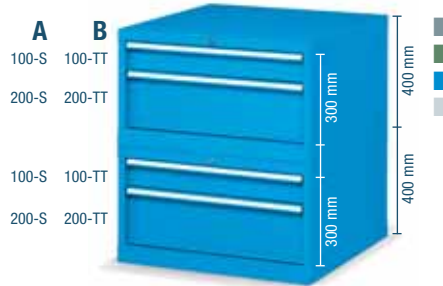

A B
100-S 100-TT
200-S 200-TT
100-S 100-TT
200-S 200-TT

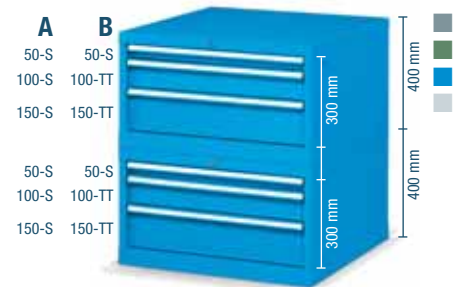

A B
50-S 50-S
100-S 100-TT
150-S 150-TT
50-S 50-S
100-S 100-TT
150-S 150-TT

| ORD. NO. | TYPE |
|------------------------------------|------|
| F AG 2016 01 04 | A |
| F AG 2016 51 04 | B |
| Cabinet with 3 drawers | |
| Dim. mm 717x726x400 h Central lock | |

| ORD. NO. | TYPE |
|------------------------------------|------|
| F AG 2016 02 04 | A |
| F AG 2016 52 04 | B |
| Cabinet with 2+2 drawers | |
| Dim. mm 717x726x800 h Central lock | |

| ORD. NO. | TYPE |
|------------------------------------|------|
| F AG 2016 03 04 | A |
| F AG 2016 53 04 | B |
| Cabinet with 3+3 drawers | |
| Dim. mm 717x726x800 h Central lock | |



A B
50-S 50-S
100-S 100-TT
100-S 100-TT
150-S 150-TT
200-S 200-TT

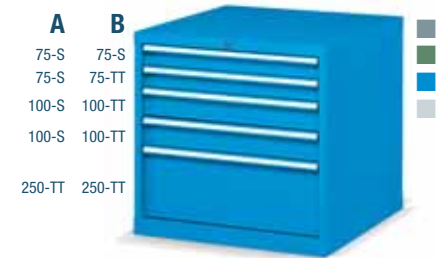

A B
75-S 75-S
75-S 75-TT
100-S 100-TT
100-S 100-TT
250-TT 250-TT

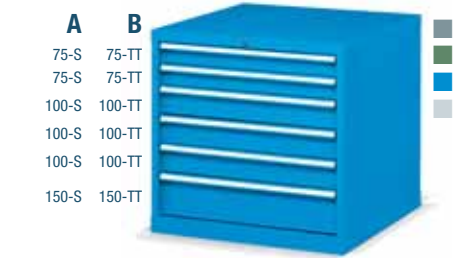

A B
75-S 75-TT
75-S 75-TT
100-S 100-TT
100-S 100-TT
100-S 100-TT
150-S 150-TT

| ORD. NO. | TYPE |
|------------------------------------|------|
| F AG 2028 01 04 | A |
| F AG 2028 51 04 | B |
| Cabinet with 5 drawers | |
| Dim. mm 717x726x700 h Central lock | |

| ORD. NO. | TYPE |
|------------------------------------|------|
| F AG 2028 02 04 | A |
| F AG 2028 52 04 | B |
| Cabinet with 5 drawers | |
| Dim. mm 717x726x700 h Central lock | |

| ORD. NO. | TYPE |
|------------------------------------|------|
| F AG 2028 03 04 | A |
| F AG 2028 53 04 | B |
| Cabinet with 6 drawers | |
| Dim. mm 717x726x700 h Central lock | |

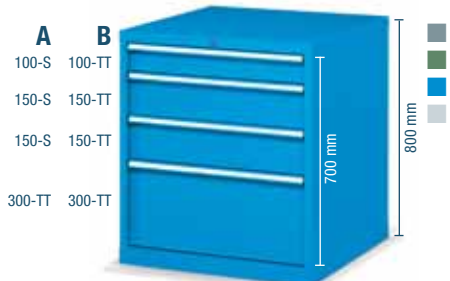

A B
100-S 100-TT
150-S 150-TT
150-S 150-TT
300-TT 300-TT

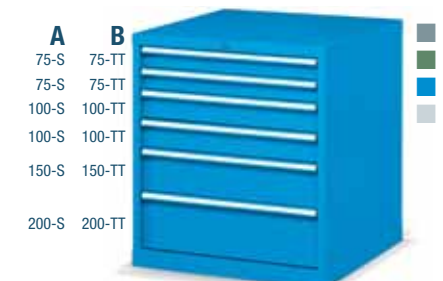

A B
75-S 75-TT
75-S 75-TT
100-S 100-TT
100-S 100-TT
150-S 150-TT
200-S 200-TT

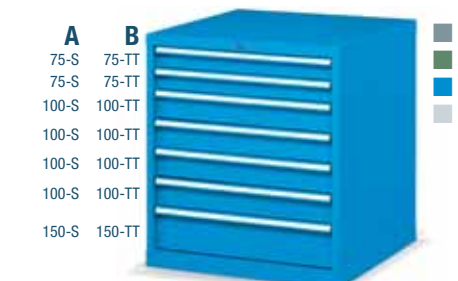

A B
75-S 75-TT
75-S 75-TT
100-S 100-TT
100-S 100-TT
100-S 100-TT
100-S 100-TT
150-S 150-TT

| ORD. NO. | TYPE |
|------------------------------------|------|
| F AG 2032 01 04 | A |
| F AG 2032 51 04 | B |
| Cabinet with 4 drawers | |
| Dim. mm 717x726x800 h Central lock | |

| ORD. NO. | TYPE |
|------------------------------------|------|
| F AG 2032 02 04 | A |
| F AG 2032 52 04 | B |
| Cabinet with 6 drawers | |
| Dim. mm 717x726x800 h Central lock | |

| ORD. NO. | TYPE |
|------------------------------------|------|
| F AG 2032 03 04 | A |
| F AG 2032 53 04 | B |
| Cabinet with 7 drawers | |
| Dim. mm 717x726x800 h Central lock | |

KEY

RAL 7000 F.01 RAL 6011 F.02 RAL 5012 F.04 RAL 7035 F.08



- The cabinets must be secured to the floor or to the wall.
- TT = telescopic full extension (100%)
- S = normal extension (87%)

Partitioning material: see page A96

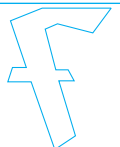

LENGTH = 717 mm DEPTH = 726 mm (36x36 Eh)

CABINETS SERIES STANDARD G

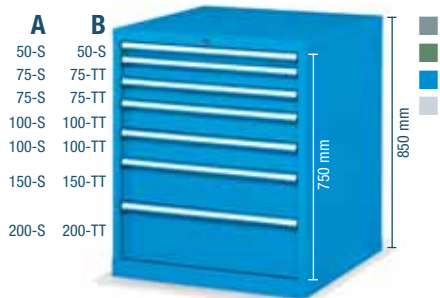

- | | |
|----------|----------|
| A | B |
| 50-S | 50-S |
| 75-S | 75-TT |
| 75-S | 75-TT |
| 100-S | 100-TT |
| 100-S | 100-TT |
| 150-S | 150-TT |
| 200-S | 200-TT |

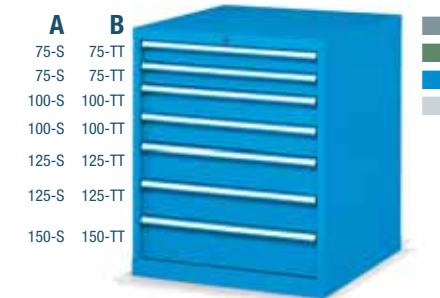

- | | |
|----------|----------|
| A | B |
| 75-S | 75-TT |
| 75-S | 75-TT |
| 100-S | 100-TT |
| 100-S | 100-TT |
| 125-S | 125-TT |
| 125-S | 125-TT |
| 150-S | 150-TT |

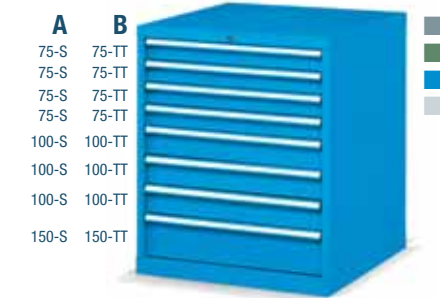

- | | |
|----------|----------|
| A | B |
| 75-S | 75-TT |
| 75-S | 75-TT |
| 75-S | 75-TT |
| 75-S | 75-TT |
| 100-S | 100-TT |
| 100-S | 100-TT |
| 100-S | 100-TT |
| 150-S | 150-TT |

| • ORD. NO. | TYPE |
|------------------------------------|----------|
| F AG 2034 01 04 | A |
| F AG 2034 51 04 | B |
| Cabinet with 7 drawers | |
| Dimensions mm 717x726x850 h | |
| Central lock | |

| • ORD. NO. | TYPE |
|------------------------------------|----------|
| F AG 2034 02 04 | A |
| F AG 2034 52 04 | B |
| Cabinet with 7 drawers | |
| Dimensions mm 717x726x850 h | |
| Central lock | |

| • ORD. NO. | TYPE |
|------------------------------------|----------|
| F AG 2034 03 04 | A |
| F AG 2034 53 04 | B |
| Cabinet with 8 drawers | |
| Dimensions mm 717x726x850 h | |
| Central lock | |

EXAMPLE INCLUDING:

| ORD. NO. |
|--|
| F AG ZA02 00 56 |
| 1 corner cabinet |
| 6 cabinets with drawers |
| retractable shelves, adjustable shelves |
| rubber cover MDF top |
| Tools, containers and partitioning material excluded |



■ RAL 7035 + ■ RAL 7000

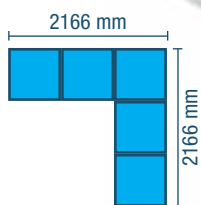

Height 1030/2000 mm

- RAL 7000 F... ..01
- RAL 6011 F... ..02
- RAL 5012 F... ..04
- RAL 7035 F... ..08

KEY ■

- The cabinets must be secured to the floor or to the wall.
- TT = telescopic full extension (100%)
- S = normal extension (87%)

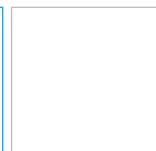
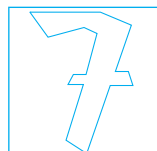

■ Partitioning material: see page **A180**

■ Partitioning material: see page **A96**

LENGTH = 717 mm DEPTH = 726 mm (36x36 Eh)

CABINETS SERIES STANDARD G

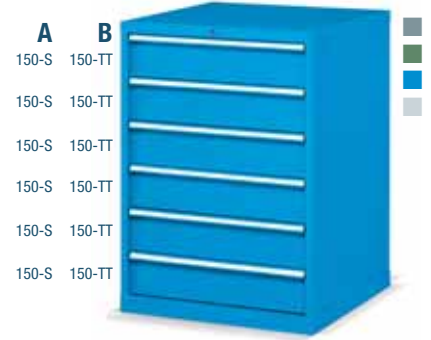
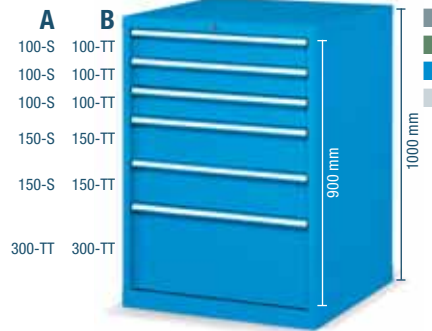

ORD. NO.

F AG 2040 25 04

Cabinet with 2 height adjustable shelves

Dimensions mm 717x726x1000 h

Central lock

ORD. NO.

TYPE

F AG 2040 01 04

A

F AG 2040 51 04

B

Cabinet with 6 drawers

Dim. mm 717x726x1000 h

Central lock

ORD. NO.

TYPE

F AG 2040 11 04

A

F AG 2040 61 04

B

Cabinet with 6 drawers

Dim. mm 717x726x1000 h

Central lock

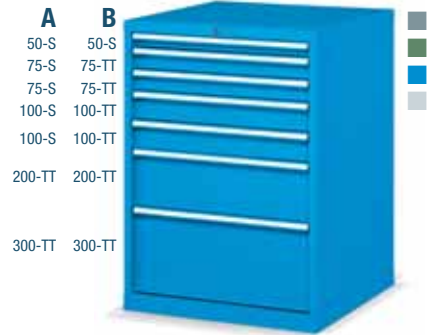
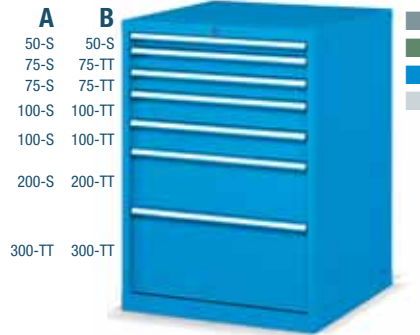
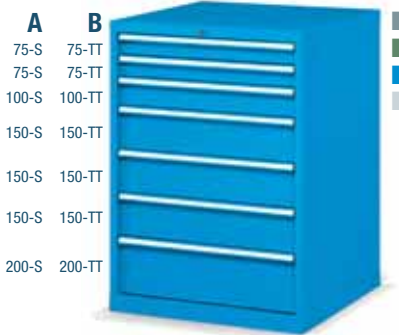

ORD. NO.

TYPE

F AG 2040 12 04

A

F AG 2040 53 04

B

Cabinet with 7 drawers

Dim. mm 717x726x1000 h

Central lock

ORD. NO.

TYPE

F AG 2040 16 04

A

F AG 2040 52 04

B

Cabinet with 7 drawers

Dim. mm 717x726x1000 h

Central lock

ORD. NO.

TYPE

F AG 2040 02 04

A

F AG 2040 52 04

B

Cabinet with 7 drawers

Dim. mm 717x726x1000 h

Central lock

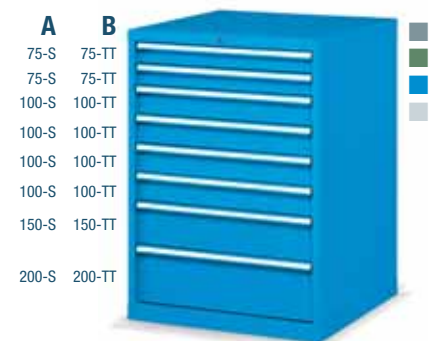
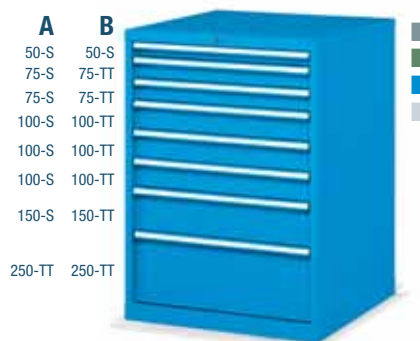
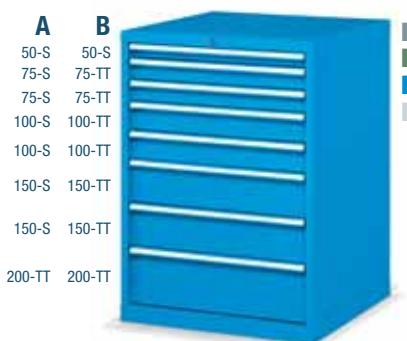

ORD. NO.

TYPE

F AG 2040 04 04

A

F AG 2040 54 04

B

Cabinet with 8 drawers

Dim. mm 717x726x1000 h

Central lock

ORD. NO.

TYPE

F AG 2040 17 04

A

F AG 2040 67 04

B

Cabinet with 8 drawers

Dim. mm 717x726x1000 h

Central lock

ORD. NO.

TYPE

F AG 2040 18 04

A

F AG 2040 68 04

B

Cabinet with 8 drawers

Dim. mm 717x726x1000 h

Central lock

KEY

RAL 7000 F.01

RAL 6011 F.02

RAL 5012 F.04

RAL 7035 F.08



- The cabinets must be secured to the floor or to the wall.
- TT = telescopic full extension (100%)
- S = normal extension (87%)
- PR = height adjustable shelf

■ Partitioning material: see page A96

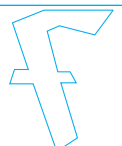

CABINETS SERIES STANDARD G

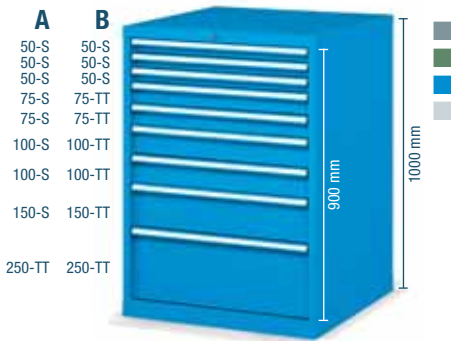

| ORD. NO. | TYPE |
|-------------------------------------|----------|
| F AG 2040 05 04 | A |
| F AG 2040 55 04 | B |
| Cabinet with 9 drawers | |
| Dim. mm 717x726x1000 h Central lock | |

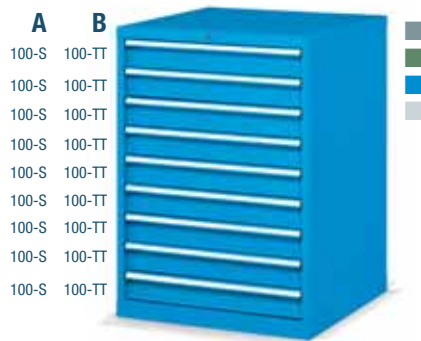

| ORD. NO. | TYPE |
|-------------------------------------|----------|
| F AG 2040 10 04 | A |
| F AG 2040 60 04 | B |
| Cabinet with 9 drawers | |
| Dim. mm 717x726x1000 h Central lock | |

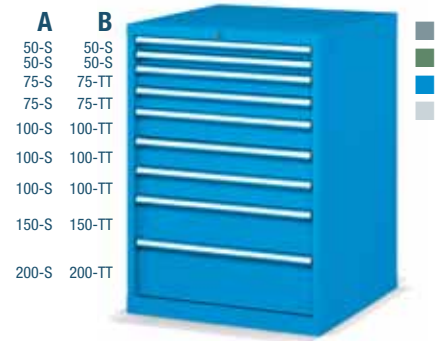

| ORD. NO. | TYPE |
|-------------------------------------|----------|
| F AG 2040 19 04 | A |
| F AG 2040 69 04 | B |
| Cabinet with 9 drawers | |
| Dim. mm 717x726x1000 h Central lock | |

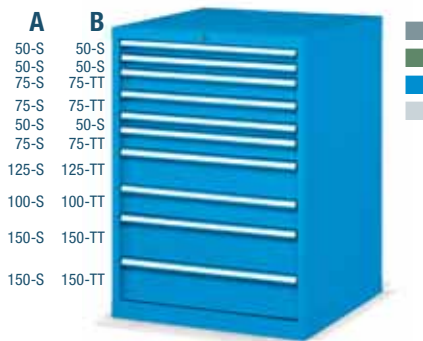

| ORD. NO. | TYPE |
|-------------------------------------|----------|
| F AG 2040 20 04 | A |
| F AG 2040 70 04 | B |
| Cabinet with 10 drawers | |
| Dim. mm 717x726x1000 h Central lock | |

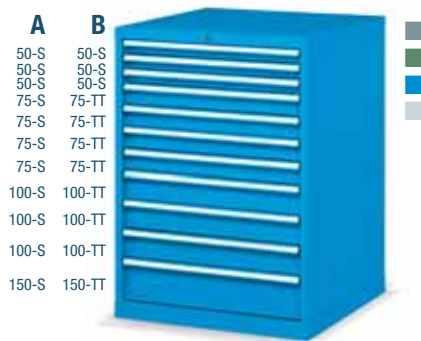

| ORD. NO. | TYPE |
|-------------------------------------|----------|
| F AG 2040 08 04 | A |
| F AG 2040 58 04 | B |
| Cabinet with 11 drawers | |
| Dim. mm 717x726x1000 h Central lock | |

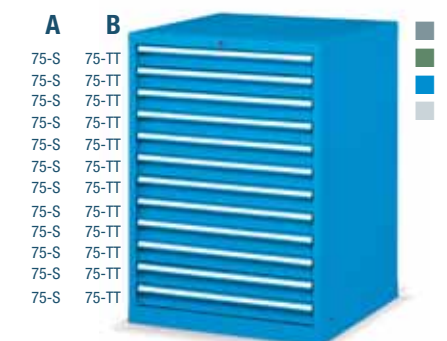

| ORD. NO. | TYPE |
|-------------------------------------|----------|
| F AG 2040 21 04 | A |
| F AG 2040 71 04 | B |
| Cabinet with 12 drawers | |
| Dim. mm 717x726x1000 h Central lock | |



| ORD. NO. | TYPE |
|--|----------|
| F AG 2040 22 04 | A |
| F AG 2040 72 04 | B |
| Cabinet with 1 drawer, 1 retractable shelf, 1 adjustable shelf | |
| Dimensions mm 717x726x1000 h | |
| Without lock, with anti-tilt rod | |

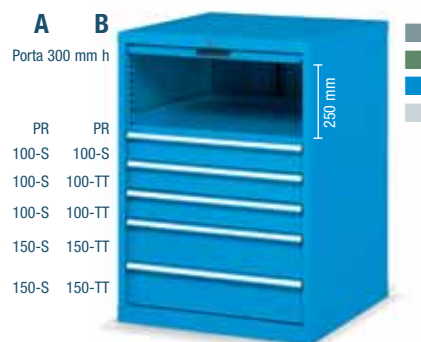

| ORD. NO. | TYPE |
|------------------------------|----------|
| F AG 2040 26 04 | A |
| F AG 2040 76 04 | B |
| Cabinet with 5 drawers | |
| Dimensions mm 717x726x1000 h | |
| Central lock | |

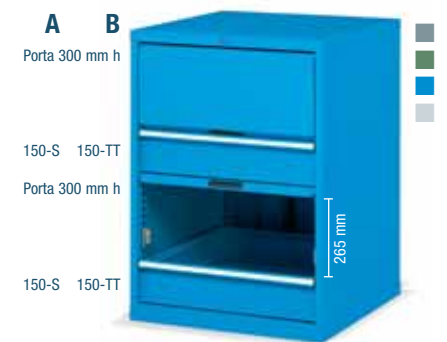

| ORD. NO. | TYPE |
|------------------------------|----------|
| F AG 2040 27 04 | A |
| F AG 2040 77 04 | B |
| Cabinet with 2 drawers | |
| Dimensions mm 717x726x1000 h | |
| Central lock | |

- RAL 7000 F.01
- RAL 6011 F.02
- RAL 5012 F.04
- RAL 7035 F.08

KEY

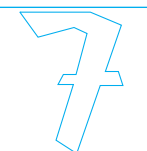

■ Single lock see page A58

■ Partitioning material: see page A96

■ The cabinets must be secured to the floor or to the wall.

- TT = telescopic full extension (100%)
- PE-TT = full telescopic retractable shelf (100%)
- S = normal extension (87%)
- PE-S = normal retractable shelf (87%)
- PR = height adjustable shelf



LENGTH = 717 mm DEPTH = 726 mm (36x36 Eh)

CABINETS SERIES STANDARD G

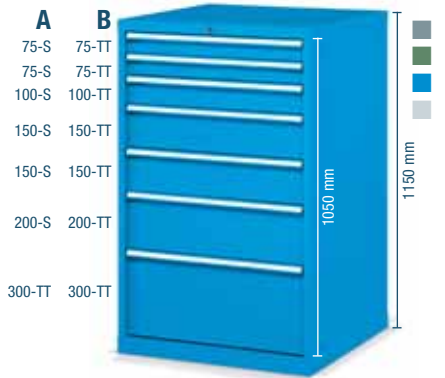

| ORD. NO. | TYPE |
|-------------------------------------|------|
| F AG 2046 07 04 | A |
| F AG 2046 57 04 | B |
| Cabinet with 7 drawers | |
| Dim. mm 717x726x1150 h Central lock | |

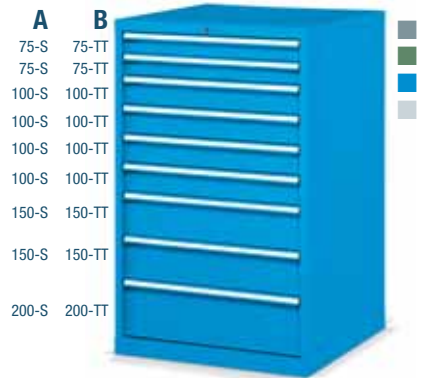

| ORD. NO. | TYPE |
|-------------------------------------|------|
| F AG 2046 08 04 | A |
| F AG 2046 58 04 | B |
| Cabinet with 9 drawers | |
| Dim. mm 717x726x1150 h Central lock | |

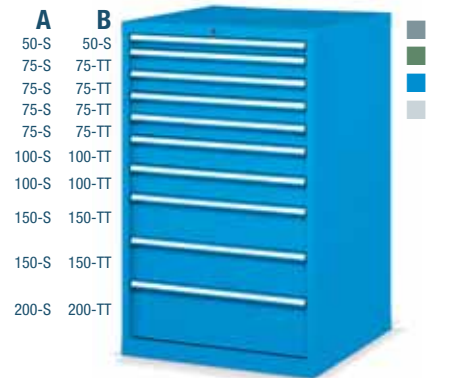

| ORD. NO. | TYPE |
|-------------------------------------|------|
| F AG 2046 09 04 | A |
| F AG 2046 59 04 | B |
| Cabinet with 10 drawers | |
| Dim. mm 717x726x1150 h Central lock | |

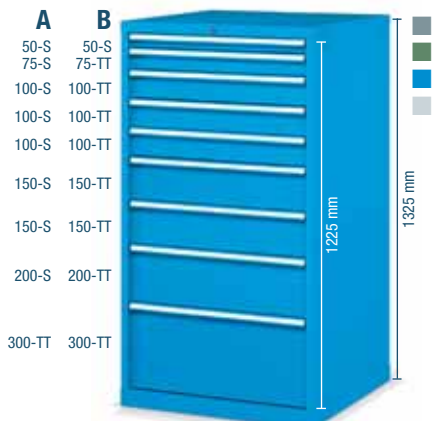

| ORD. NO. | TYPE |
|-------------------------------------|------|
| F AG 2053 07 04 | A |
| F AG 2053 57 04 | B |
| Cabinet with 9 drawers | |
| Dim. mm 717x726x1325 h Central lock | |

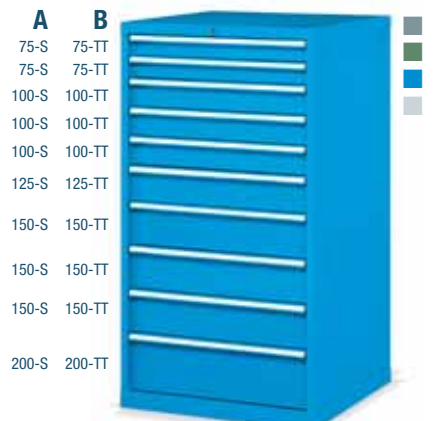

| ORD. NO. | TYPE |
|-------------------------------------|------|
| F AG 2053 08 04 | A |
| F AG 2053 58 04 | B |
| Cabinet with 10 drawers | |
| Dim. mm 717x726x1325 h Central lock | |

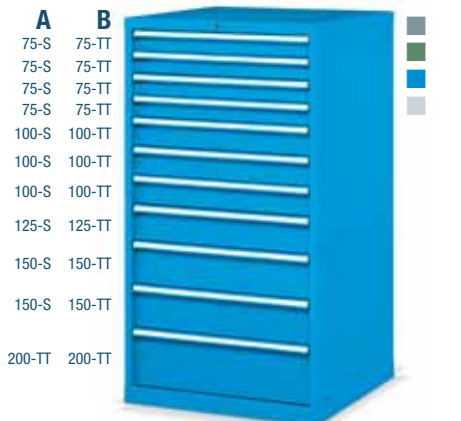

| ORD. NO. | TYPE |
|-------------------------------------|------|
| F AG 2053 03 04 | A |
| F AG 2053 53 04 | B |
| Cabinet with 11 drawers | |
| Dim. mm 717x726x1325 h Central lock | |

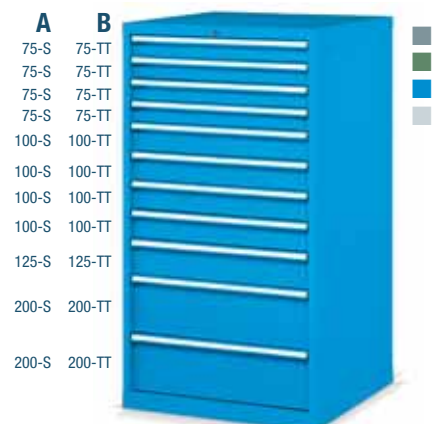

| ORD. NO. | TYPE |
|-------------------------------------|------|
| F AG 2053 09 04 | A |
| F AG 2053 59 04 | B |
| Cabinet with 11 drawers | |
| Dim. mm 717x726x1325 h Central lock | |

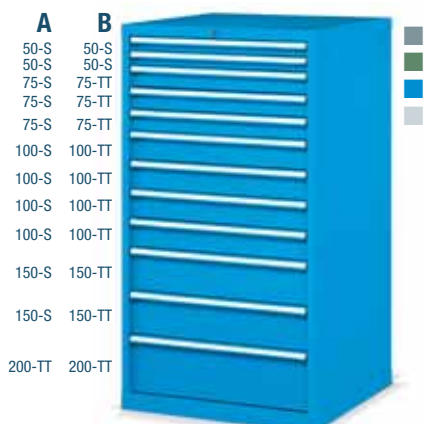

| ORD. NO. | TYPE |
|-------------------------------------|------|
| F AG 2053 05 04 | A |
| F AG 2053 55 04 | B |
| Cabinet with 12 drawers | |
| Dim. mm 717x726x1325 h Central lock | |

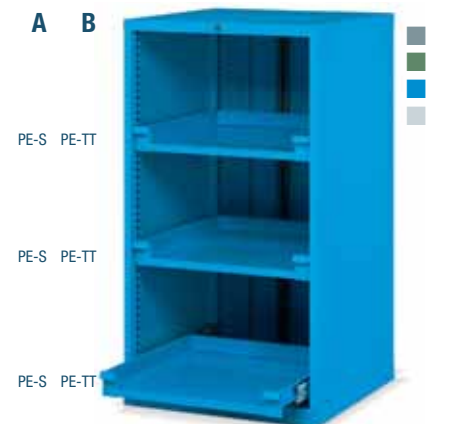

| ORD. NO. | TYPE |
|---|------|
| F AG 2053 10 04 | A |
| F AG 2053 60 04 | B |
| Cabinet with 3 retractable shelves | |
| Dim. mm 717x726x1325 h Without lock, with anti-tilt rod | |

KEY



- TT = telescopic full extension (100%)
- PE-TT = full telescopic retractable shelf (100%)
- S = normal extension (87%)
- PE-S = normal retractable shelf (87%)

RAL 7000 F.01

RAL 6011 F.02

RAL 5012 F.04

RAL 7035 F.08

■ The cabinets must be secured to the floor or to the wall.

■ Partitioning material: see page A96

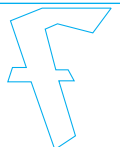

CABINETS SERIES STANDARD G

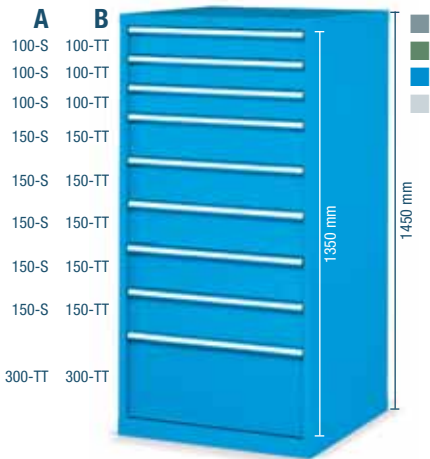

| ORD. NO. | TYPE |
|------------------------|--------------|
| F AG 2058 07 04 | A |
| F AG 2058 57 04 | B |
| Cabinet with 9 drawers | |
| Dim. mm 717x726x1450 h | Central lock |



| ORD. NO. | TYPE |
|------------------------|--------------|
| F AG 2058 08 04 | A |
| F AG 2058 58 04 | B |
| Cabinet with 9 drawers | |
| Dim. mm 717x726x1450 h | Central lock |

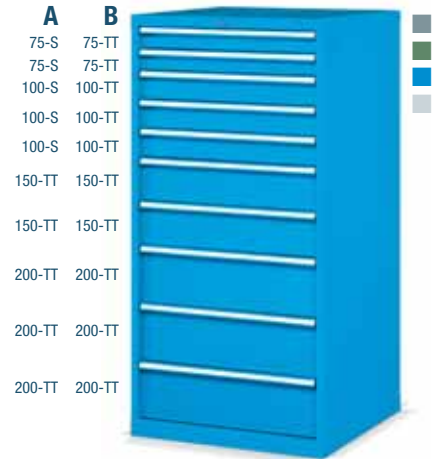

| ORD. NO. | TYPE |
|-------------------------|--------------|
| F AG 2058 02 04 | A |
| F AG 2058 52 04 | B |
| Cabinet with 10 drawers | |
| Dim. mm 717x726x1450 h | Central lock |

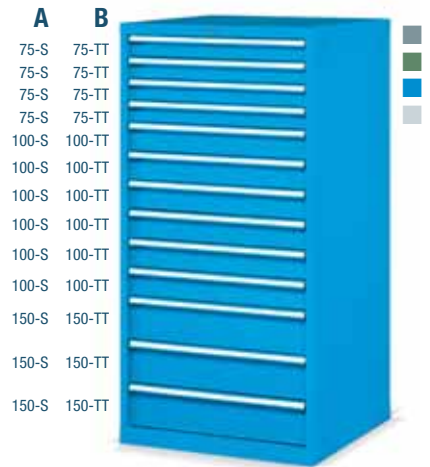

| ORD. NO. | TYPE |
|-------------------------|--------------|
| F AG 2058 09 04 | A |
| F AG 2058 59 04 | B |
| Cabinet with 13 drawers | |
| Dim. mm 717x726x1450 h | Central lock |



| ORD. NO. | TYPE |
|--|----------------------------------|
| F AG 2058 10 04 | A |
| F AG 2058 60 04 | B |
| Cabinet with 2 retractable shelves, 1 adjustable shelf | |
| Dimensions mm 717x726x1450 h | Without lock, with anti-tilt rod |



| ORD. NO. | TYPE |
|------------------------------|--------------|
| F AG 2058 11 04 | A |
| F AG 2058 61 04 | B |
| Cabinet with 3 drawers | |
| Dimensions mm 717x726x1450 h | Central lock |

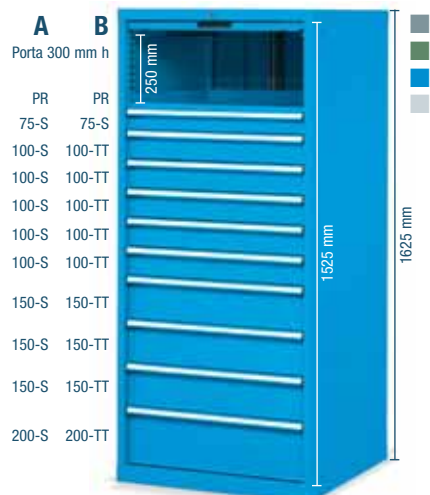

| ORD. NO. | TYPE |
|-------------------------|--------------|
| F AG 2065 10 04 | A |
| F AG 2065 60 04 | B |
| Cabinet with 10 drawers | |
| Dim. mm 717x726x1625 h | Central lock |

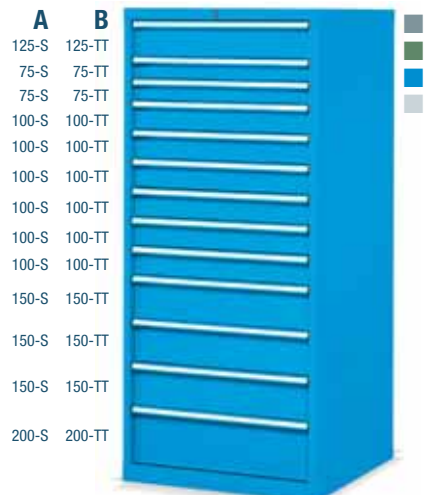

| ORD. NO. | TYPE |
|-------------------------|--------------|
| F AG 2065 07 04 | A |
| F AG 2065 57 04 | B |
| Cabinet with 13 drawers | |
| Dim. mm 717x726x1625 h | Central lock |



| ORD. NO. | TYPE |
|-------------------------|--------------|
| F AG 2065 09 04 | A |
| F AG 2065 59 04 | B |
| Cabinet with 14 drawers | |
| Dim. mm 717x726x1625 h | Central lock |

LENGTH = 717 mm DEPTH = 726 mm (36x36 Eh)

CABINETS SERIES STANDARD G

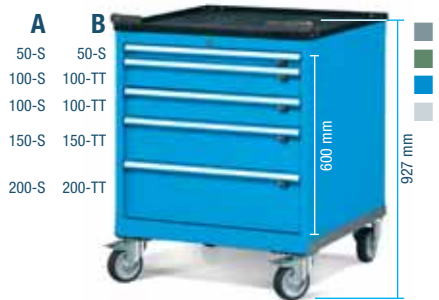

| ORD. NO. | TYPE |
|--|------|
| F AG S228 01 04 | A |
| F AG S228 51 04 | B |
| Cabinet with 5 drawers, cabinet load capacity: 400 kg Ø 125 mm wheels in elastic rubber Dim. mm 717x802x927 h Central lock | |



| ORD. NO. | TYPE |
|--|------|
| F AG S228 02 04 | A |
| F AG S228 52 04 | B |
| Cabinet with 5 drawers, cabinet load capacity: 400 kg Ø 125 mm wheels in elastic rubber Dim. mm 717x802x927 h Central lock | |



| ORD. NO. | TYPE |
|--|------|
| F AG S228 03 04 | A |
| F AG S228 53 04 | B |
| Cabinet with 6 drawers, cabinet load capacity: 400 kg Ø 125 mm wheels in elastic rubber Dim. mm 717x802x927 h Central lock | |



| ORD. NO. | TYPE |
|---|------|
| F AG S232 01 04 | A |
| F AG S232 51 04 | B |
| Cabinet with 4 drawers, portata armadio: 400 kg Ø 125 mm wheels in elastic rubber Dim. mm 717x802x1027 h Central lock | |



| ORD. NO. | TYPE |
|---|------|
| F AG S232 02 04 | A |
| F AG S232 52 04 | B |
| Cabinet with 6 drawers, portata armadio: 400 kg Ø 125 mm wheels in elastic rubber Dim. mm 717x802x1027 h Central lock | |



| ORD. NO. | TYPE |
|---|------|
| F AG S232 03 04 | A |
| F AG S232 53 04 | B |
| Cabinet with 7 drawers, portata armadio: 400 kg Ø 125 mm wheels in elastic rubber Dim. mm 717x802x1027 h Central lock | |



| ORD. NO. | TYPE |
|---|------|
| F AG S234 01 04 | A |
| F AG S234 51 04 | B |
| Cabinet with 7 drawers Cabinet load capacity: 400 kg Ø 125 mm wheels in elastic rubber Dim. mm 717x802x1077 h Central lock | |



| ORD. NO. | TYPE |
|---|------|
| F AG S234 02 04 | A |
| F AG S234 52 04 | B |
| Cabinet with 7 drawers Cabinet load capacity: 400 kg Ø 125 mm wheels in elastic rubber Dim. mm 717x802x1077 h Central lock | |



| ORD. NO. | TYPE |
|---|------|
| F AG S234 03 04 | A |
| F AG S234 53 04 | B |
| Cabinet with 8 drawers Cabinet load capacity: 400 kg Ø 125 mm wheels in elastic rubber Dim. mm 717x802x1077 h Central lock | |

KEY



- TT = telescopic full extension (100%)
- S = normal extension (87%)
- PR = height adjustable shelf
- All indicated loads are net and refer to evenly distributed weights.



■ The handles can be fitted towards the bottom thereby reducing the height by 38 mm.

■ Partitioning material: see page A96



RAL 7000 F... ..01 RAL 6011 F... ..02 RAL 5012 F... ..04 RAL 7035 F... ..08

CABINETS SERIES STANDARD G

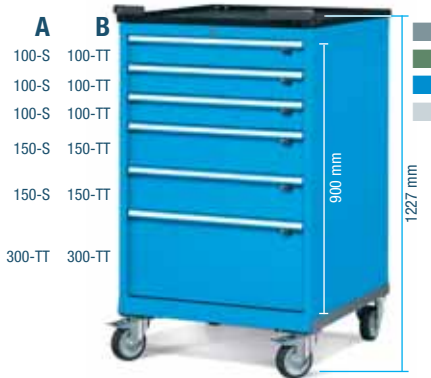

- | | |
|----------|----------|
| A | B |
| 100-S | 100-TT |
| 100-S | 100-TT |
| 100-S | 100-TT |
| 150-S | 150-TT |
| 150-S | 150-TT |
| 300-TT | 300-TT |



- | | |
|----------|----------|
| A | B |
| 75-S | 75-TT |
| 75-S | 75-TT |
| 100-S | 100-TT |
| 150-S | 150-TT |
| 150-S | 150-TT |
| 150-S | 150-TT |
| 200-S | 200-TT |



- | | |
|----------|----------|
| A | B |
| 50-S | 50-S |
| 75-S | 75-TT |
| 75-S | 75-TT |
| 100-S | 100-TT |
| 100-S | 100-TT |
| 150-S | 150-TT |
| 150-S | 150-TT |
| 200-S | 200-TT |

| ORD. NO. | TYPE |
|-------------------------------------|----------|
| F AG S240 01 04 | A |
| F AG S240 51 04 | B |
| Cabinet with 6 drawers | |
| Cabinet load capacity: 400 kg | |
| Ø 125 mm wheels in elastic rubber | |
| Dimensions mm 717x802x1227 h | |
| Central lock | |

| ORD. NO. | TYPE |
|-------------------------------------|----------|
| F AG S240 02 04 | A |
| F AG S240 52 04 | B |
| Cabinet with 7 drawers | |
| Cabinet load capacity: 400 kg | |
| Ø 125 mm wheels in elastic rubber | |
| Dimensions mm 717x802x1227 h | |
| Central lock | |

| ORD. NO. | TYPE |
|-------------------------------------|----------|
| F AG S240 04 04 | A |
| F AG S240 54 04 | B |
| Cabinet with 8 drawers | |
| Cabinet load capacity: 400 kg | |
| Ø 125 mm wheels in elastic rubber | |
| Dimensions mm 717x802x1227 h | |
| Central lock | |

■ The door can be closed by the edge of the lower drawer handle (ref. Y)



RAL 7000 F... ..01 RAL 6011 F... ..02 RAL 5012 F... ..04 RAL 7035 F... ..08

KEY ■

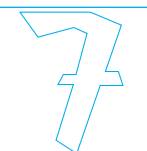

■ Partitioning material: see page A96

■ The handles can be fitted towards the bottom thereby reducing the height by 38 mm.



- TT = telescopic full extension (100%)
- S = normal extension (87%)
- All indicated loads are net and refer to evenly distributed weights.



LENGTH = 717 mm DEPTH = 726 mm (36x36 Eh)

CABINETS SERIES STANDARD G

EXAMPLE INCLUDING:**ORD. NO.****F AG L234 S1 50**

1 cabinet with wheels complete with 4 drawers

1 adjustable shelf

1 flap door

1 MDF top with rubber covering

1 perforated back panel

Dimensions mm 717x802x1091/1791 h

Tools, hooks and toolboxes excluded



RAL 7035 + RAL 5012

KEY

RAL 7000 F... ..01

RAL 6011 F... ..02

RAL 5012 F... ..04

RAL 7035 F... ..08

■ Partitioning material: see page **A96**■ Hooks see page **C66**

■ All indicated loads are net and refer to evenly distributed weights.

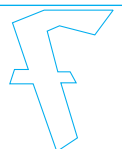

CABINETS SERIES STANDARD G

EMPTY CABINETS

| ORD. NO. | USABLE HEIGHT mm | LOAD CAPACITY kg | DIMENSIONS mm |
|-----------------|------------------|------------------|----------------|
| F AG 2016 00 04 | 300 | 3100 | 717x726x400 h |
| F AG 2028 00 04 | 600 | 3100 | 717x726x700 h |
| F AG 2032 00 04 | 700 | 3100 | 717x726x800 h |
| F AG 2034 00 04 | 750 | 3100 | 717x726x850 h |
| F AG 2040 00 04 | 900 | 3100 | 717x726x1000 h |
| F AG 2046 00 04 | 1050 | 3100 | 717x726x1150 h |
| F AG 2053 00 04 | 1225 | 3100 | 717x726x1325 h |
| F AG 2058 00 04 | 1350 | 3100 | 717x726x1450 h |
| F AG 2065 00 04 | 1525 | 3100 | 717x726x1625 h |



■ 01 ■ 02 ■ 04 ■ 08

■ The cabinets must be secured to the floor or to the wall. If the cabinets are stacked they must be secured to the wall and their load capacity must be divided by 2. Further information for fixing set see page A82.

SPARE LOCK

ORD. NO. R CSR 0003 00
for cabinet

NORMAL EXTENSION DRAWERS (S)

| ORD. NO. | FRONT HEIGHT mm | LOAD CAPACITY kg | USABLE DIMENSIONS mm |
|-----------------|-----------------|------------------|----------------------|
| F FG 2005 00 04 | 50 | 60 | 600x600x36 h |
| F FG 2007 00 04 | 75 | 80 | 600x600x61 h |
| F FG 2010 00 04 | 100 | 100 | 600x600x86 h |
| F FG 2012 00 04 | 125 | 100 | 600x600x111 h |
| F FG 2015 00 04 | 150 | 100 | 600x600x136 h |
| F FG 2017 00 04 | 175 | 100 | 600x600x161 h |
| F FG 2020 00 04 | 200 | 100 | 600x600x186 h |
| F FG 2030 00 04 | 300 | 100 | 600x600x286 h |

Normal extension (87%)



■ 01
■ 02
■ 04
■ 08

■ Partitioning material: see page A96-A97

FULL TELESCOPIC EXTENSION DRAWERS (TT)

| ORD. NO. | FRONT HEIGHT mm | LOAD CAPACITY kg | USABLE DIMENSIONS mm |
|-----------------|-----------------|------------------|----------------------|
| F FG 2107 00 04 | 75 | 200 | 600x600x54 h |
| F FG 2110 00 04 | 100 | 200 | 600x600x79 h |
| F FG 2112 00 04 | 125 | 200 | 600x600x104 h |
| F FG 2115 00 04 | 150 | 200 | 600x600x129 h |
| F FG 2117 00 04 | 175 | 200 | 600x600x154 h |
| F FG 2120 00 04 | 200 | 200 | 600x600x179 h |
| F FG 2125 00 04 | 250 | 200 | 600x600x229 h |
| F FG 2130 00 04 | 300 | 200 | 600x600x279 h |
| F FG 2140 00 04 | 400 | 200 | 600x600x379 h |

Full telescopic extension (100%)

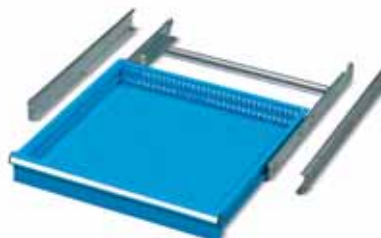

■ 01
■ 02
■ 04
■ 08

■ Partitioning material: see page A96-A97

NORMAL EXTENSION SHELVES (PE-S)

| ORD. NO. | SIDE HEIGHT mm | LOAD CAPACITY kg | USABLE DIMENSIONS mm |
|-----------------|----------------|------------------|----------------------|
| F FG 8020 00 04 | - | 100 | 610x610 |

Normal extension (87%)



■ 01
■ 02
■ 04
■ 08

FULL TELESCOPIC EXTENSION SHELVES (PE-TT)

| ORD. NO. | SIDE HEIGHT mm | LOAD CAPACITY kg | USABLE DIMENSIONS mm |
|-----------------|----------------|------------------|----------------------|
| F FG 8120 00 04 | - | 200 | 610x610 |

Full telescopic extension (100%)

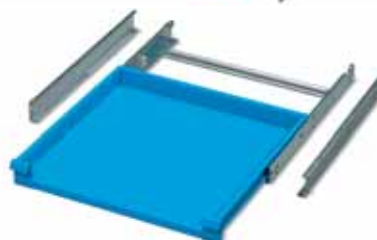

■ 01
■ 02
■ 04
■ 08

ADJUSTABLE SHELVES

| ORD. NO. | SIDE HEIGHT mm | LOAD CAPACITY kg | USABLE DIMENSIONS mm |
|-----------------|----------------|------------------|----------------------|
| F SR 1260 01 04 | 25 | 150 | 618x618 |

Without extension system



■ 01
■ 02
■ 04
■ 08

LENGTH = 717 mm DEPTH = 726 mm (36x36 Eh)

CABINETS SERIES STANDARD G

CABINET TO CABINET FIXING

■ The article includes:
4 M8 nuts and bolts

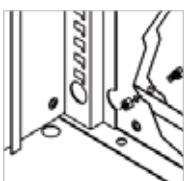

ORD. NO. F AG 9202 00 99

**TWO SIDED ADHESIVE TAPE**

ORD. NO.

R CMV 0025 00

width 15 mm, length 50 metres



■ 07

TOP SHELF

ORD. NO.

DIMENSIONS mm

F AG 9003 01 07

717x726x20 h

oil-resistant rubber cover top with 3 edges



■ 07

PLINTHS

ORD. NO.

F RR 0070 00 07

Plinths height 50 mm



■ 07

PLINTHS FOR TRANSPALLET

ORD. NO.

F RR 0310 00 07 Plinths height 100 mm

F RR 0405 00 07 Facing piece

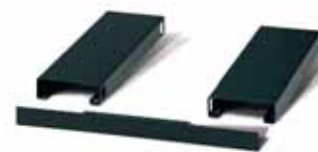

■ 07

PLINTHS FOR FORK LIFT TRUCK

ORD. NO.

F RR 0230 00 07 Pair of plinths height 60 mm

F RR 0400 00 07 Facing piece

EXAMPLE INCLUDING:

ORD. NO.

F AG 2040 S2 56

9 drawers

1 rubber cover top with 3 edges

1 plinth for transpallet

Dimensions mm 717x726x1120 h

Tools and partitioning material excluded



■ RAL 7035 +
■ RAL 7000

plinth for transpallet

■ INFO

RAL 7000 F... ..01

RAL 6011F... ..02

RAL 5012F... ..04

RAL 7035F... ..08



www.famispa.com



CABINETS SERIES STANDARD G

UPPER MDF TOP WITH RUBBER COVERING DIMENSIONS 718x726x31,5 mm H

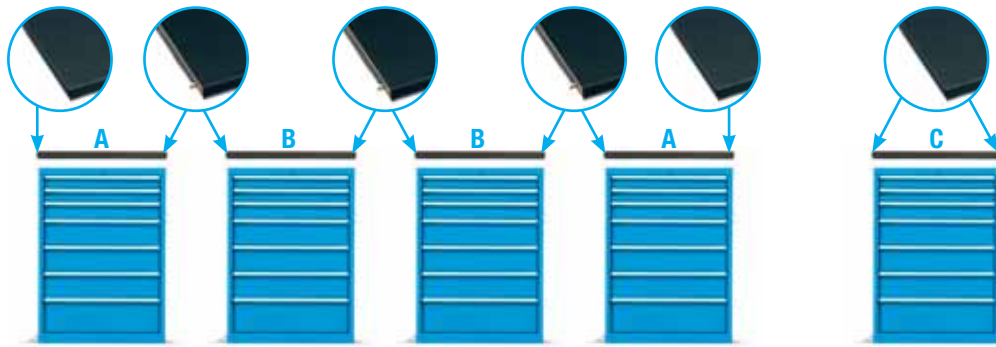

ORD. NO. F UZ 9999 00 00

Drilling of the cabinet upper shelf for the MDF top fixing.



Detail of the oil-resistant rubber

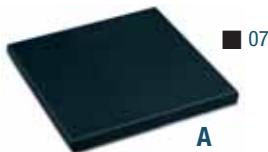

ORD. NO.

F UZ 3220 11 07

MDF top with rubber covering

Side profile

For end cabinets

Oil-resistant rubber mat

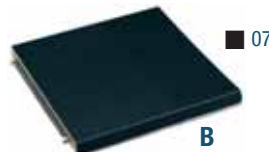

ORD. NO.

F UZ 3220 12 07

MDF top with rubber covering

No side profile

For additional central cabinets Oil-resist. rubber mat

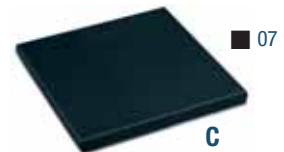

ORD. NO.

F UZ 3220 13 07

MDF top with rubber covering

2 side profiles

For single cabinet

Oil-resistant rubber mat

CABINETS PREPARED FOR WHEELS

Cabinets prepared for wheels including: wheel plate, 4 edged top with oil-resistant rubber, 2 steel handles covered with shock-resistant rubber, cylinder lock with 2 keys, anti-tilt rod.

■ The single drawer opening system
ORD. NO. F DD 9400 00 07 must be applied to all drawers of mobile cabinets.



ORD. NO.

F AG 0228 00 04

Overall dim. mm:

717x802x767 h without wheels

*Wheel plate thickness

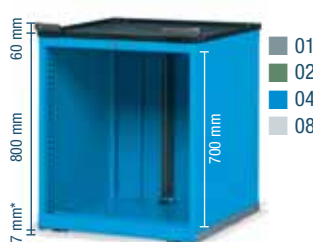

ORD. NO.

F AG 0232 00 04

Overall dim. mm:

717x802x867 h without wheels

*Wheel plate thickness



ORD. NO.

F AG 0234 00 04

Overall dim. mm:

717x802x917 h without wheels

*Wheel plate thickness

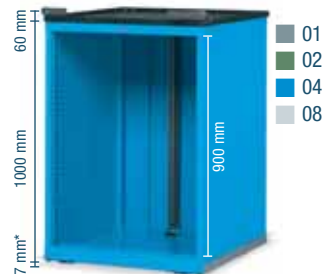

ORD. NO.

F AG 0240 00 04

Overall dim. mm:

717x802x1067 h without wheels

*Wheel plate thickness

ELASTIC RUBBER SWIVEL WHEEL WITH BRAKE

| ORD. NO. | Ø mm | CABINET LOAD CAPACITY | C mm |
|----------------|------|-----------------------|------|
| C RG DCE15 125 | 125 | 400 kg | 160 |

ELASTIC RUBBER FIXED WHEEL

| ORD. NO. | Ø mm | CABINET LOAD CAPACITY | C mm |
|----------------|------|-----------------------|------|
| C RG BCE15 125 | 125 | 400 kg | 160 |

NYLON SWIVEL WHEEL WITH BRAKE

| ORD. NO. | Ø mm | CABINET LOAD CAPACITY | C mm |
|----------------|------|-----------------------|------|
| C RN DAD10 100 | 100 | 235 kg | 130 |
| C RN DAD11 125 | 125 | 400 kg | 160 |

NYLON FIXED WHEEL

| ORD. NO. | Ø mm | CABINET LOAD CAPACITY | C mm |
|----------------|------|-----------------------|------|
| C RN BAD10 100 | 100 | 235 kg | 130 |
| C RN BAD11 125 | 125 | 400 kg | 160 |

RAL 7000 F... ..01 RAL 6011 F... ..02 RAL 5012 F... ..04 RAL 7035 F... ..08

KEY ■

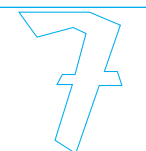

■ Other types of wheels see page A52

■ The handles can be fitted towards the bottom thereby reducing the height by 38 mm.



■ All indicated loads are net and refer to evenly distributed weights.



LENGTH = 717 mm DEPTH = 726 mm (36x36 Eh)

CABINETS SERIES STANDARD G

PERFORATED BACK PANEL

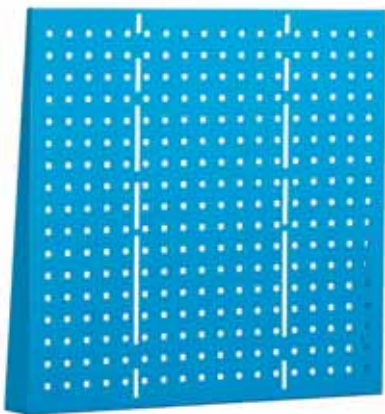

■ 01
■ 02
■ 04

| ORD. NO. | DIMENSIONS mm |
|-----------------|---------------|
| F DF 7942 00 04 | 716x93x420 h |
| F DF 7970 00 04 | 716x93x700 h |

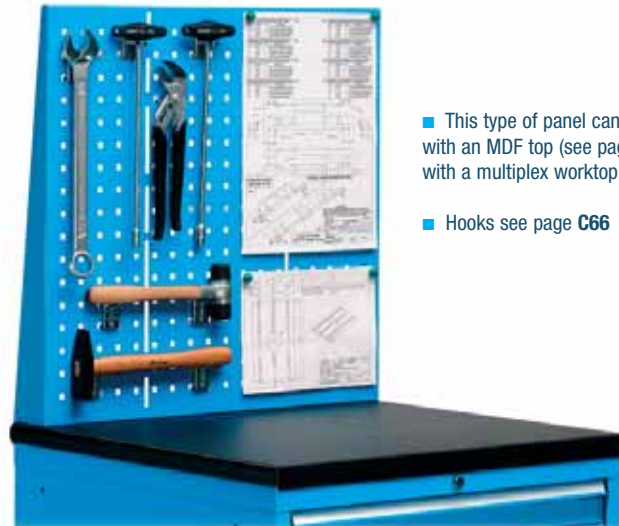

■ This type of panel can be applied with an MDF top (see page A94) or with a multiplex worktop.

■ Hooks see page C66

FLAP DOOR

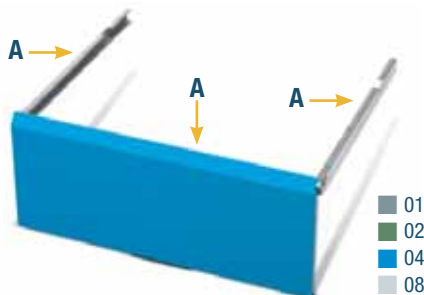

■ 01
■ 02
■ 04
■ 08

| ORD. NO. | REFERENCE |
|-----------------|-----------|
| F AG 9530 00 04 | A+(Cx2) |

Flap door with 2 guides and 2 brackets to block the door with the lower drawer locked.

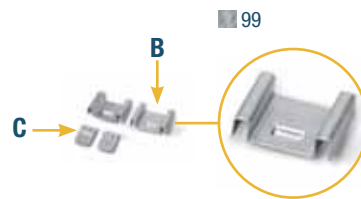

| ORD. NO. | REFERENCE |
|-----------------|-----------|
| F DA 9698 00 99 | B |

The order number includes just 1 piece. 2 pieces are needed for each door.



■ The two stops (ref. B) must be used when the door is fitted along with the normal or full telescopic extension drawer (ref. Z). See photo ref. 5 page A79 to understand the usable internal volume.

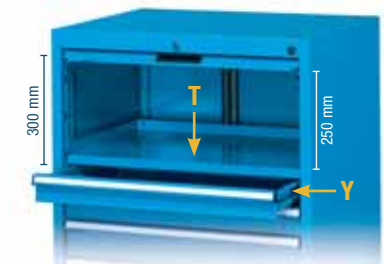

■ The two stops (ref. B) are not required when the door is fitted along with the adjustable shelf (ref. T) ORD. NO. F SR 1260 01 .. N. B. the drawer (ref. Y) must be normal extension.

■ The door can be closed by the edge of the lower drawer handle (ref. Y)



RACK



| ORD. NO. |
|-------------|
| C MV 99 126 |

Standard (600x150 mm) CD or DVD rack.

Warning: The rack is supplied with length of 36 Eh (600 mm).



■ Standard CD or DVD cases (142x10x125 mm) can be stored into the 175 mm h drawer (with 4 ORD. NO. C MV 99 126 racks). The cases can be stored with their **spines facing upwards**. The racks are supplied with a length of 36 Eh (600 mm).

Quantity of CD/DVD cases which can be stored in one drawer:

drawer 175 normal extension: 120 pcs.

drawer 175 full telescopic extension: 160 pcs.



■ Standard CD or DVD cases (142x10x125 mm) can be stored into the 150 mm h drawer (with 4 ORD. NO. C MV 99 126 racks). The cases can be stored with their **spines facing sideways**. The racks are supplied with a length of 36 Eh (600 mm).

Quantity of CD/DVD cases which can be stored in one drawer:

drawer 150 normal extension: 120 pcs.

drawer 150 full telescopic extension: 160 pcs.

CABINETS SERIES STANDARD G

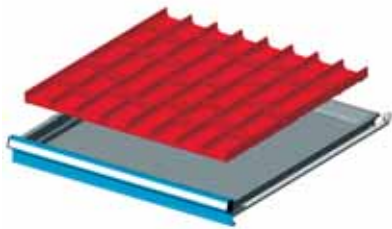

| ORD. NO. | FOR FRONT HEIGHTS |
|------------------------|-------------------|
| F FH 2005 15 00 | 50-300 |
| Set including: | |
| 16 Troughs | 2 grooves |
| 35 Plain partitions | 73 mm |

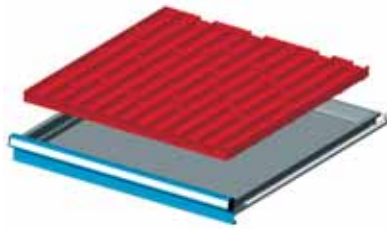

| ORD. NO. | FOR FRONT HEIGHTS |
|------------------------|-------------------|
| F FH 2005 16 00 | 50-300 |
| Set including: | |
| 16 Troughs | 3 grooves |
| 50 Plain partitions | 47 mm |

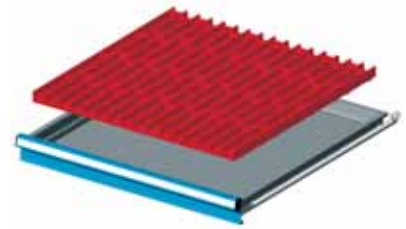

| ORD. NO. | FOR FRONT HEIGHTS |
|------------------------|-------------------|
| F FH 2005 17 00 | 50-300 |
| Set including: | |
| 16 Troughs | 4 grooves |
| 65 Plain partitions | 36 mm |

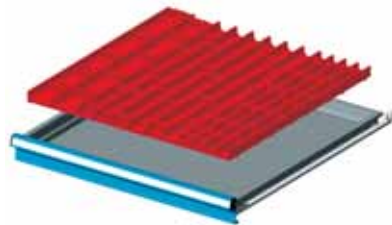

| ORD. NO. | FOR FRONT HEIGHTS |
|------------------------|-------------------|
| F FH 2005 20 00 | 50-300 |
| Set including: | |
| 4 Troughs | 4 grooves |
| 30 Plain partitions | 36 mm |
| 8 Troughs | 3 grooves |
| 20 Plain partitions | 47 mm |
| 4 Troughs | 2 grooves |
| 10 Plain partitions | 73 mm |

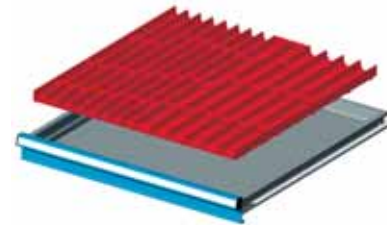

| ORD. NO. | FOR FRONT HEIGHTS |
|------------------------|-------------------|
| F FH 2005 21 00 | 50-300 |
| Set including: | |
| 8 Troughs | 4 grooves |
| 24 Plain partitions | 36 mm |
| 8 Troughs | 3 grooves |
| 16 Plain partitions | 47 mm |

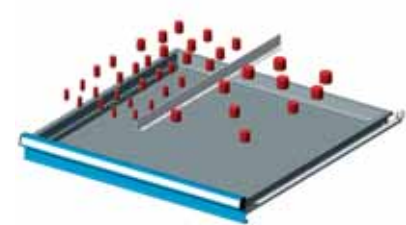

| ORD. NO. | FOR FRONT HEIGHTS |
|------------------------|-------------------|
| F FH 2005 19 00 | 50-300 |
| Set including: | |
| 1 Plain partition | 610 mm |
| 10 Cutter holders | Ø 12,2 mm |
| 10 Cutter holders | Ø 15,5 mm |
| 10 Cutter holders | Ø 21,5 mm |
| 5 Cutter holders | Ø 26,5 mm |
| 5 Cutter holders | Ø 31,2 mm |

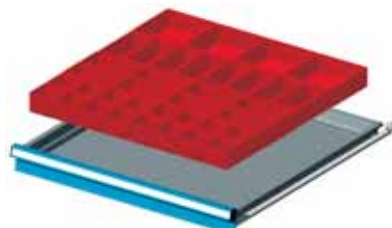

| ORD. NO. | FOR FRONT HEIGHTS |
|------------------------|-------------------|
| F FH 2005 12 00 | 50 |
| F FH 2007 12 00 | 75 |
| Set including: | |
| 16 Plastic boxes | 75x75 mm |
| 16 Plastic boxes | 150x75 mm |
| 4 Plastic boxes | 150x150 mm |



| ORD. NO. | FOR FRONT HEIGHTS |
|------------------------|-------------------|
| F FH 2005 13 00 | 50 |
| F FH 2007 13 00 | 75 |
| F FH 2010 13 00 | 100-125 |
| Set including: | |
| 16 Plastic boxes | 150x75 mm |
| 8 Plastic boxes | 150x150 mm |

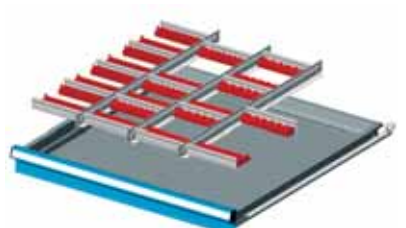

| ORD. NO. | FOR FRONT HEIGHTS |
|------------------------|-------------------|
| F FH 2005 25 00 | 50-300 |
| Set including: | |
| 3 Slotted partitions | 610 mm |
| 15 Plain partitions | 149 mm |
| 4 Angle trays | 6 grooves |
| 3 Angle trays | 8 grooves |
| 4 Angle trays | 11 grooves |

INFO ■

■ Partitioning material: see page A180

www.famispa.com



LENGTH = 717 mm DEPTH = 726 mm (36x36 Eh)

CABINETS SERIES STANDARD G

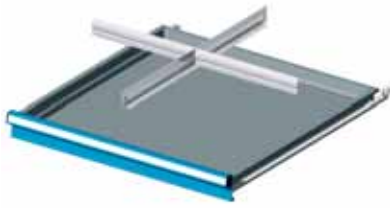

| ORD. NO. | FOR FRONT HEIGHTS |
|------------------------|-------------------|
| F FH 2005 05 00 | 50 |
| F FH 2007 05 00 | 75 |
| F FH 2010 05 00 | 100-125 |
| F FH 2015 05 00 | 150-175 |
| F FH 2020 05 00 | 200-250 |
| F FH 2030 05 00 | 300 |
| Set including: | |
| 1 Slotted partition | 610 mm |
| 2 Plain partitions | 302 mm |

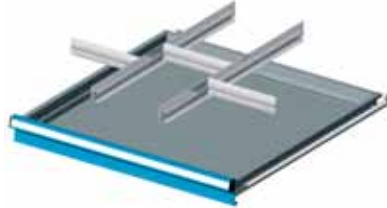

| ORD. NO. | FOR FRONT HEIGHTS |
|------------------------|-------------------|
| F FH 2005 06 00 | 50 |
| F FH 2007 06 00 | 75 |
| F FH 2010 06 00 | 100-125 |
| F FH 2015 06 00 | 150-175 |
| F FH 2020 06 00 | 200-250 |
| F FH 2030 06 00 | 300 |
| Set including: | |
| 2 Slotted partitions | 610 mm |
| 3 Plain partitions | 200 mm |

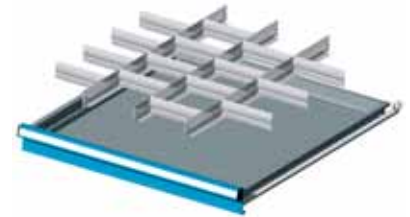

| ORD. NO. | FOR FRONT HEIGHTS |
|------------------------|-------------------|
| F FH 2005 07 00 | 50 |
| F FH 2007 07 00 | 75 |
| F FH 2010 07 00 | 100-125 |
| F FH 2015 07 00 | 150-175 |
| F FH 2020 07 00 | 200-250 |
| Set including: | |
| 3 Slotted partitions | 610 mm |
| 15 Plain partitions | 149 mm |



| ORD. NO. | FOR FRONT HEIGHTS |
|------------------------|-------------------|
| F FH 2005 22 00 | 50 |
| F FH 2007 22 00 | 75 |
| F FH 2010 22 00 | 100-125 |
| F FH 2015 22 00 | 150-175 |
| F FH 2020 22 00 | 200-250 |
| Set including: | |
| 4 Plain partitions | 610 mm |

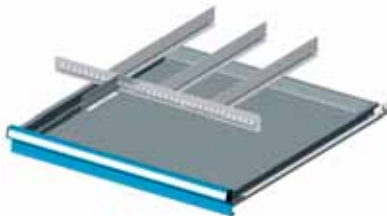

| ORD. NO. | FOR FRONT HEIGHTS |
|------------------------|-------------------|
| F FH 2005 23 00 | 50 |
| F FH 2007 23 00 | 75 |
| F FH 2010 23 00 | 100-125 |
| F FH 2015 23 00 | 150-175 |
| F FH 2020 23 00 | 200-250 |
| Set including: | |
| 1 Slotted partition | 610 mm |
| 3 Plain partitions | 455 mm |
| 1 Plain partition | 149 mm |

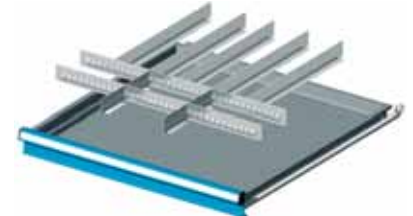

| ORD. NO. | FOR FRONT HEIGHTS |
|------------------------|-------------------|
| F FH 2005 24 00 | 50 |
| F FH 2007 24 00 | 75 |
| F FH 2010 24 00 | 100-125 |
| F FH 2015 24 00 | 150-175 |
| Set including: | |
| 1 Slotted partition | 610 mm |
| 5 Plain partitions | 405 mm |
| 4 Plain partitions | 98 mm |

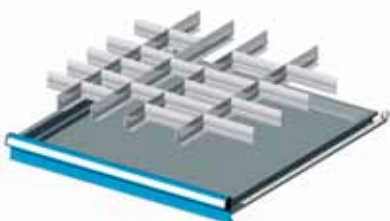

| ORD. NO. | FOR FRONT HEIGHTS |
|------------------------|-------------------|
| F FH 2005 08 00 | 50 |
| F FH 2007 08 00 | 75 |
| F FH 2010 08 00 | 100-125 |
| Set including: | |
| 4 Slotted partitions | 610 mm |
| 12 Plain partitions | 98 mm |
| 9 Plain partitions | 149 mm |

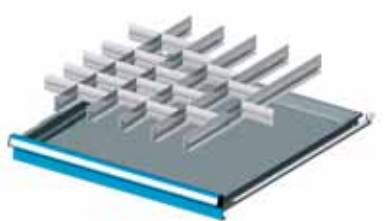

| ORD. NO. | FOR FRONT HEIGHTS |
|------------------------|-------------------|
| F FH 2005 09 00 | 50 |
| F FH 2007 09 00 | 75 |
| F FH 2010 09 00 | 100-125 |
| F FH 2015 09 00 | 150-175 |
| Set including: | |
| 5 Slotted partitions | 610 mm |
| 20 Plain partitions | 98 mm |

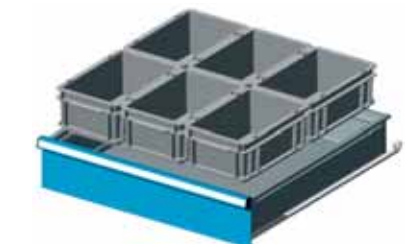

| ORD. NO. | FOR FRONT HEIGHTS |
|------------------------|-------------------|
| F FH 2015 18 00 | 150-175 |
| F FH 2020 18 00 | 200-250 |
| Set including: | |
| 6 Cassette athena | 300x200 mm |

■ INFO

www.famispa.com

■ Partitioning material: see page A180

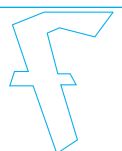

ORD. NO. F BL 1020 00 00
Steel vice 130 mm



ORD. NO. F AG 3040 S1 51
RAL 5012+7000



ORD. NO. F AG L334 S1 51
RAL 5012+7000

45 EH (753 mm)

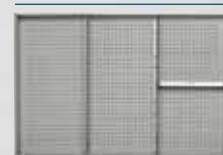

36 EH (600 mm)

FLOOR FIXING SET



2x

- 2 "HILTI" plugs for concrete floors \geq to classes B25/RBK250/MPA 25 N/mm²
- Recommended traction of the plug: 2.9 KN
- Plug diameter: \varnothing 6 mm

ORD. NO. F AG 9204 00 99

CABINET FLOOR FIXING SET

- Pair of spare galvanised brackets
- \varnothing 6 mm hole



ORD. NO. F AG 9200 00 99

CABINET

ORD. NO.

F AG 3040 S1 51

- Complete with 8 drawers
- 1 multiplex worktop 40 mm thickness
- 1 plinth for transpallet
- Dimensions mm 870x750x1140 h

Tools and partitioning material excluded

CABINET WITH WHEELS

ORD. NO.

F AG L334 S1 51

- Complete with 7 drawers
- 1 MDF top with rubber covering
- Dimensions mm 945x727x1091 h

RAL 7000 F.01

RAL 6011 F.02

RAL 5012 F.04

RAL 7035 F.08

SUPPLEMENTARY PARTS ■



- Partitioning material: see page A104



- Spare key. Always indicate the number on the cylinder lock of the key to be replaced.

ORD. NO. R CSC 0002 00

- Master key. This type of key opens all the 45 and 46 series locks.

ORD. NO. R CSC 0001 00



LENGTH = 870 mm DEPTH = 726 mm (45x36 Eh)

CABINETS SERIES STANDARD GG

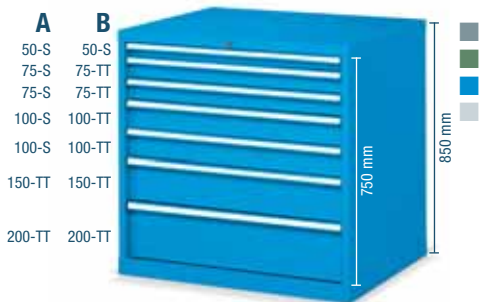

A 50-S 50-S
75-S 75-TT
75-S 75-TT
100-S 100-TT
100-S 100-TT
150-TT 150-TT
200-TT 200-TT

850 mm
750 mm

| ORD. NO. | TYPE |
|------------------------|--------------|
| F AG 3034 01 04 | A |
| F AG 3034 51 04 | B |
| Cabinet with 7 drawers | |
| Dim. mm 870x726x850 h | Central lock |

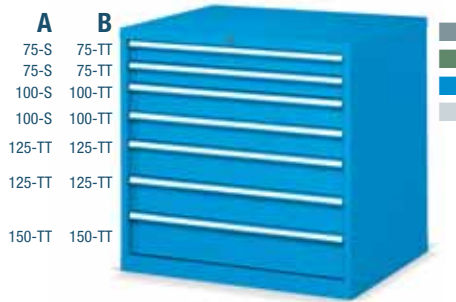

A 75-S 75-TT
75-S 75-TT
100-S 100-TT
100-S 100-TT
125-TT 125-TT
125-TT 125-TT
150-TT 150-TT

850 mm

| ORD. NO. | TYPE |
|------------------------|--------------|
| F AG 3034 02 04 | A |
| F AG 3034 52 04 | B |
| Cabinet with 7 drawers | |
| Dim. mm 870x726x850 h | Central lock |

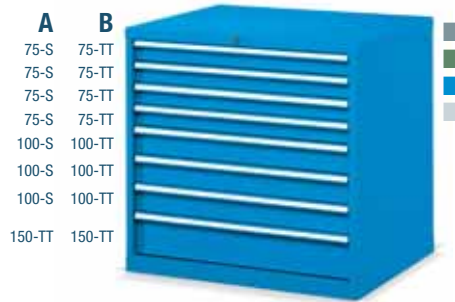

A 75-S 75-TT
75-S 75-TT
75-S 75-TT
75-S 75-TT
100-S 100-TT
100-S 100-TT
100-S 100-TT
150-TT 150-TT

850 mm

| ORD. NO. | TYPE |
|------------------------|--------------|
| F AG 3034 03 04 | A |
| F AG 3034 53 04 | B |
| Cabinet with 8 drawers | |
| Dim. mm 870x726x850 h | Central lock |

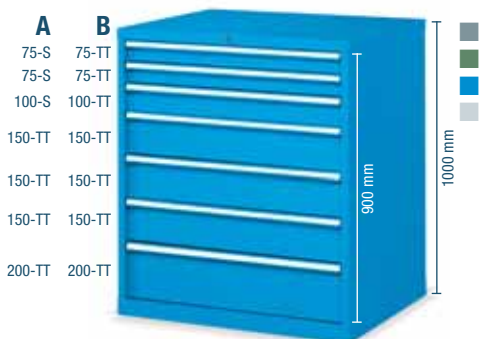

A 75-S 75-TT
75-S 75-TT
100-S 100-TT
150-TT 150-TT
150-TT 150-TT
150-TT 150-TT
200-TT 200-TT

1000 mm
900 mm

| ORD. NO. | TYPE |
|------------------------|--------------|
| F AG 3040 02 04 | A |
| F AG 3040 52 04 | B |
| Cabinet with 7 drawers | |
| Dim. mm 870x726x1000 h | Central lock |

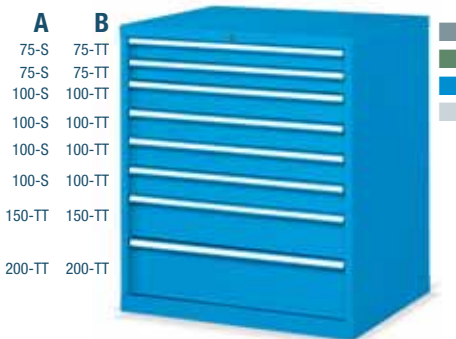

A 75-S 75-TT
75-S 75-TT
100-S 100-TT
100-S 100-TT
100-S 100-TT
100-S 100-TT
150-TT 150-TT
200-TT 200-TT

1000 mm

| ORD. NO. | TYPE |
|------------------------|--------------|
| F AG 3040 04 04 | A |
| F AG 3040 54 04 | B |
| Cabinet with 8 drawers | |
| Dim. mm 870x726x1000 h | Central lock |

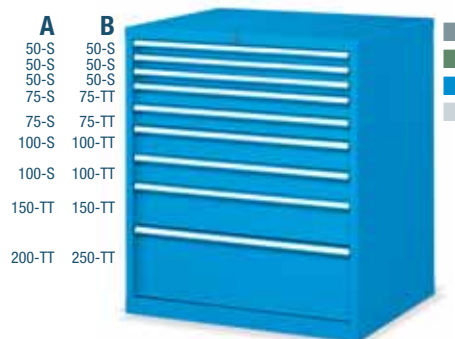

A 50-S 50-S
50-S 50-S
50-S 50-S
75-S 75-TT
75-S 75-TT
100-S 100-TT
100-S 100-TT
150-TT 150-TT
200-TT 250-TT

1000 mm

| ORD. NO. | TYPE |
|------------------------|--------------|
| F AG 3040 05 04 | A |
| F AG 3040 55 04 | B |
| Cabinet with 9 drawers | |
| Dim. mm 870x726x1000 h | Central lock |

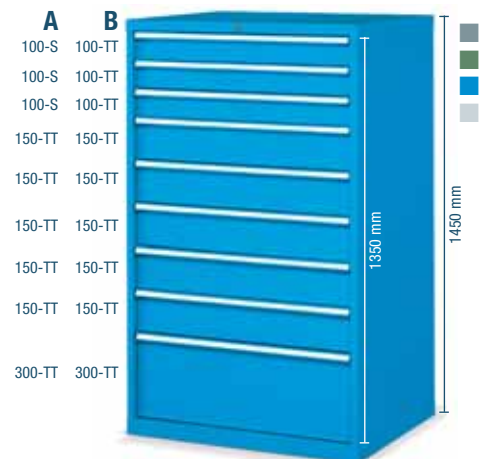

A 100-S 100-TT
100-S 100-TT
100-S 100-TT
150-TT 150-TT
150-TT 150-TT
150-TT 150-TT
150-TT 150-TT
150-TT 150-TT
150-TT 150-TT
300-TT 300-TT

1450 mm
1350 mm

| ORD. NO. | TYPE |
|------------------------|--------------|
| F AG 3058 01 04 | A |
| F AG 3058 51 04 | B |
| Cabinet with 9 drawers | |
| Dim. mm 870x726x1450 h | Central lock |

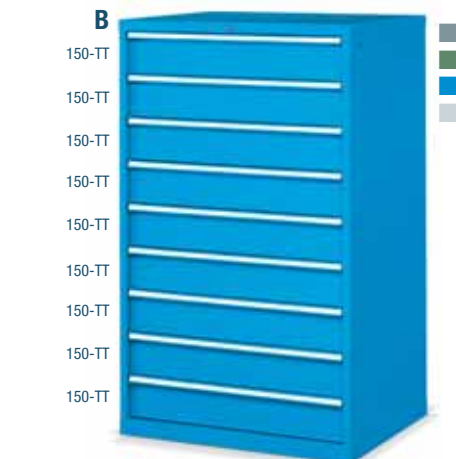

B 150-TT
150-TT
150-TT
150-TT
150-TT
150-TT
150-TT
150-TT
150-TT
150-TT
150-TT

1450 mm

| ORD. NO. | TYPE |
|------------------------|--------------|
| - | |
| F AG 3058 52 04 | B |
| Cabinet with 9 drawers | |
| Dim. mm 870x726x1450 h | Central lock |

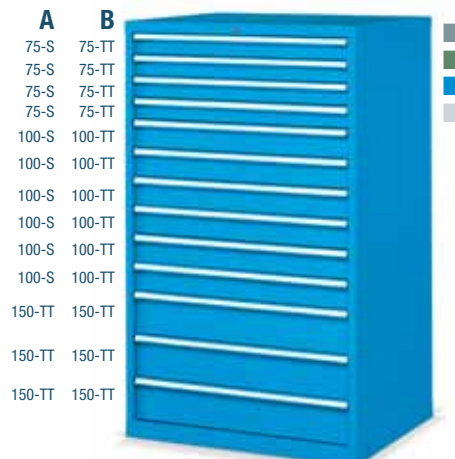

A 75-S 75-TT
75-S 75-TT
75-S 75-TT
75-S 75-TT
100-S 100-TT
100-S 100-TT
100-S 100-TT
100-S 100-TT
100-S 100-TT
150-TT 150-TT
150-TT 150-TT
150-TT 150-TT

1450 mm

| ORD. NO. | TYPE |
|-------------------------|--------------|
| F AG 3058 03 04 | A |
| F AG 3058 53 04 | B |
| Cabinet with 13 drawers | |
| Dim. mm 870x726x1450 h | Central lock |

KEY



- The cabinets must be secured to the floor or to the wall.
- TT = telescopic full extension (100%)
- S = normal extension (87%)

Partitioning material: see page A104

RAL 7000 F.01

RAL 6011 F.02

RAL 5012 F.04

RAL 7035 F.08



LENGTH = 870 mm DEPTH = 726 mm (45x36 Eh)

CABINETS SERIES STANDARD GG

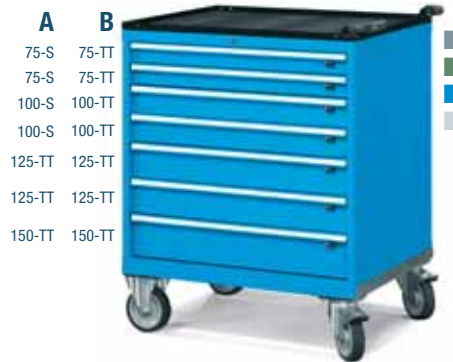

| ORD. NO. | TYPE |
|-------------------------------------|----------|
| F AG L334 01 04 | A |
| F AG L334 51 04 | B |
| Cabinet with 7 drawers | |
| Cabinet load capacity: 600 kg | |
| Ø 160 mm elastic rubber wheels | |
| Dimensions mm 945x727x1121 h | |
| Central lock | |

| ORD. NO. | TYPE |
|-------------------------------------|----------|
| F AG L334 02 04 | A |
| F AG L334 52 04 | B |
| Cabinet with 7 drawers | |
| Cabinet load capacity: 600 kg | |
| Ø 160 mm elastic rubber wheels | |
| Dimensions mm 945x727x1121 h | |
| Central lock | |

| ORD. NO. | TYPE |
|-------------------------------------|----------|
| F AG L334 03 04 | A |
| F AG L334 53 04 | B |
| Cabinet with 8 drawers | |
| Cabinet load capacity: 600 kg | |
| Ø 160 mm elastic rubber wheels | |
| Dimensions mm 945x727x1121 h | |
| Central lock | |



| ORD. NO. | TYPE |
|-------------------------------------|----------|
| F AG L340 01 04 | A |
| F AG L340 51 04 | B |
| Cabinet with 6 drawers | |
| Cabinet load capacity: 600 kg | |
| Ø 160 mm elastic rubber wheels | |
| Dimensions mm 945x727x1271 h | |
| Central lock | |

| ORD. NO. | TYPE |
|-------------------------------------|----------|
| F AG L340 02 04 | A |
| F AG L340 52 04 | B |
| Cabinet with 7 drawers | |
| Cabinet load capacity: 600 kg | |
| Ø 160 mm elastic rubber wheels | |
| Dimensions mm 945x727x1271 h | |
| Central lock | |

| ORD. NO. | TYPE |
|-------------------------------------|----------|
| F AG L340 03 04 | A |
| F AG L340 53 04 | B |
| Cabinet with 8 drawers | |
| Cabinet load capacity: 600 kg | |
| Ø 160 mm elastic rubber wheels | |
| Dimensions mm 945x727x1271 h | |
| Central lock | |

RAL 7000 F... ..01 RAL 6011 F... ..02 RAL 5012 F... ..04 RAL 7035 F... ..08

KEY ■



■ Partitioning material: see page A104

■ The handles can be fitted towards the bottom thereby reducing the height by 38 mm.

- TT = telescopic full extension (100%)
- S = normal extension (87%)
- All indicated loads are net and refer to evenly distributed weights



LENGTH = 870 mm DEPTH = 726 mm (45x36 Eh)

CABINETS SERIES STANDARD GG

CABINET WITH WHEELS**ORD. NO.****F AG L334 S1 51**complete with 7 drawers,
1 MDF top with rubber covering**Dimensions mm 945x727x1091 h**

Tools and partitioning material excluded



■ RAL 5012 + ■ RAL 7000



■ RAL 5012 + ■ RAL 7000

CABINET**ORD. NO.****F AG 3034 S1 51**

7 drawers

1 multiplex worktop 40 mm thickness

1 plinth for transpallet

Dimensions mm 870x750x990 h

Tools and partitioning material excluded

■ **INFO**

RAL 7000 F..01 RAL 6011 F..02 RAL 5012 F..04 RAL 7035 F..08

■ Partitioning material: see page A180

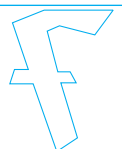
www.famispa.com

CABINETS SERIES STANDARD GG

EMPTY CABINETS

| ORD. NO. | USABLE HEIGHT mm | LOAD CAPACITY kg | DIMENSIONS mm |
|-----------------|------------------|------------------|----------------|
| F AG 3034 00 04 | 750 | 3100 | 870x726x850 h |
| F AG 3040 00 04 | 900 | 3100 | 870x726x1000 h |
| F AG 3058 00 04 | 1350 | 3100 | 870x726x1450 h |



SPARE LOCK

ORD. NO. R CSR 0003 00
for cabinet

■ 01 ■ 02 ■ 04 ■ 08

■ The cabinets must be secured to the floor or to the wall. If the cabinets are stacked they must be secured to the wall and their load capacity must be divided by 2. Further information for fixing set see page A98.

NORMAL EXTENSION DRAWERS (S)

| ORD. NO. | FRONT HEIGHT mm | LOAD CAPACITY kg | USABLE DIMENSIONS mm |
|-----------------|-----------------|------------------|----------------------|
| F FG 3005 00 04 | 50 | 60 | 753x600x36 h |
| F FG 3007 00 04 | 75 | 80 | 753x600x61 h |
| F FG 3010 00 04 | 100 | 100 | 753x600x86 h |

Normal extension (87%)



■ 01
■ 02
■ 04
■ 08

■ Partitioning material: see page A104-A105

FULL TELESCOPIC EXTENSION DRAWERS (TT)

| ORD. NO. | FRONT HEIGHT mm | LOAD CAPACITY kg | USABLE DIMENSIONS mm |
|-----------------|-----------------|------------------|----------------------|
| F FG 3107 00 04 | 75 | 200 | 753x600x54 h |
| F FG 3110 00 04 | 100 | 200 | 753x600x79 h |
| F FG 3112 00 04 | 125 | 200 | 753x600x104 h |
| F FG 3115 00 04 | 150 | 200 | 753x600x129 h |
| F FG 3120 00 04 | 200 | 200 | 753x600x179 h |
| F FG 3125 00 04 | 250 | 200 | 753x600x229 h |
| F FG 3130 00 04 | 300 | 200 | 753x600x279 h |

Full telescopic extension (100%)



■ 01
■ 02
■ 04
■ 08

■ Partitioning material: see page A104-A105

NORMAL EXTENSION SHELVES (PE-S)

| ORD. NO. | SIDE HEIGHT mm | LOAD CAPACITY kg | USABLE DIMENSIONS mm |
|-----------------|----------------|------------------|----------------------|
| F FG 8030 00 04 | - | 100 | 763x610 |

Normal extension (87%)



■ 01
■ 02
■ 04
■ 08

FULL TELESCOPIC EXTENSION SHELVES (PE-TT)

| ORD. NO. | SIDE HEIGHT mm | LOAD CAPACITY kg | USABLE DIMENSIONS mm |
|-----------------|----------------|------------------|----------------------|
| F FG 8130 00 04 | - | 200 | 763x610 |

Full telescopic extension (100%)



■ 01
■ 02
■ 04
■ 08

ADJUSTABLE SHELVES

| ORD. NO. | SIDE HEIGHT mm | LOAD CAPACITY kg | USABLE DIMENSIONS mm |
|-----------------|----------------|------------------|----------------------|
| F SR 1265 01 04 | 25 | 100 | 814x618 |

Without extension system



■ 01
■ 02
■ 04
■ 08

RAL 7000 F.01 RAL 6011 F.02 RAL 5012 F.04 RAL 7035 F.08

KEY ■

■ All indicated loads are net and refer to evenly distributed weights



LENGTH = 870 mm DEPTH = 726 mm (45x36 Eh)

CABINETS SERIES STANDARD GG

CABINET TO CABINET FIXING

■ The article includes:
4 M8 nuts and bolts

ORD. NO. F AG 9202 00 99

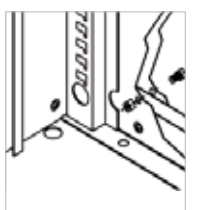

TWO SIDED ADHESIVE TAPE

ORD. NO.

R CMV 0025 00

width 15 mm, length 50 metri



■ 07

TOP SHELF

ORD. NO.

F AG 9006 01 07

DIMENSIONS mm

870x726x20 h

oil-resistant rubber cover top with 3 edges



■ 07

PLINTHS

ORD. NO.

F RR 0087 00 07

Plinths height 50 mm



■ 07

PLINTHS FOR TRANSPALLET

ORD. NO.

F RR 0235 00 07 Plinths height 100 mm

F RR 0408 00 07 Facing piece



■ 07

PLINTHS FOR FORK LIFT TRUCK

ORD. NO.

F RR 0230 00 07 Pair of plinths height 60 mm

F RR 0407 00 07 Facing piece

UPPER MDF TOP WITH RUBBER COVERING DIMENSIONS 871x726x31,5 mm H

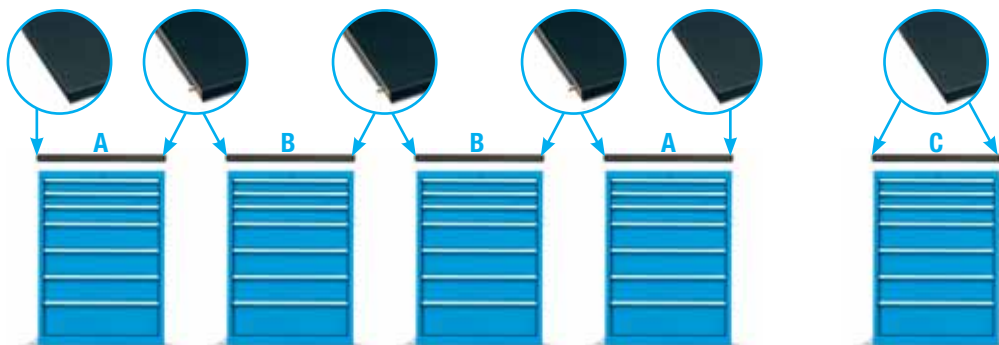

ORD. NO. F UZ 9999 00 00

Drilling of the cabinet upper shelf for the MDF top fixing.



Detail of oil-resistant rubber



■ 07

A

ORD. NO.

F UZ 3230 11 07

MDF top with rubber covering

Side profile

For end cabinets

Oil-resistant rubber mat



■ 07

B

ORD. NO.

F UZ 3230 12 07

MDF top with rubber covering

No side profile

For additional central cabinets Oil-resist. rubber mat



■ 07

C

ORD. NO.

F UZ 3230 13 07

MDF top with rubber covering

2 side profiles

For single cabinet

Oil-resistant rubber mat

■ INFO

RAL 7000 F... ..01

RAL 6011 F... ..02

RAL 5012 F... ..04

RAL 7035 F... ..08



www.famispa.com



CABINETS SERIES STANDARD GG

CABINETS PREPARED FOR WHEELS

Cabinets prepared for wheels including: wheel plate, 4 edged top with oil-resistant rubber, 2 steel handles covered with shock-resistant rubber, cylinder lock with 2 keys, anti-tilt rod.

- 01
- 02
- 04
- 08



ORD. NO.

F AG 0334 00 04

Overall dim. mm:
945x727x917 h without wheels

*Wheel plate thickness

- 01
- 02
- 04
- 08

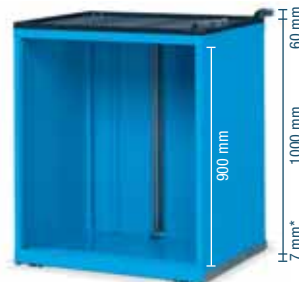

ORD. NO.

F AG 0340 00 04

Overall dim. mm:
945x727x1067 h without wheels

*Wheel plate thickness



■ The single drawer opening system **ORD. NO. F DD 9400 00 07** must be applied to all drawers of mobile cabinets.

■ Other types of wheels see page A52



ELASTIC RUBBER SWIVEL WHEEL WITH BRAKE

ORD. NO. Ø mm CABINET LOAD CAPACITY C mm

C RG DCE15 160 160 600 kg 204



ELASTIC RUBBER FIXED WHEEL

ORD. NO. Ø mm CABINET LOAD CAPACITY C mm

C RG BCE15 160 160 600 kg 204



NYLON SWIVEL WHEEL WITH BRAKE

ORD. NO. Ø mm CABINET LOAD CAPACITY C mm

C RN DAD04 160 160 600 kg 204



NYLON FIXED WHEEL

ORD. NO. Ø mm CABINET LOAD CAPACITY C mm

C RN BAD04 160 160 600 kg 204

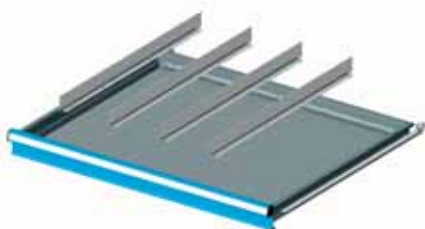

ORD. NO. FOR FRONT HEIGHTS

| | |
|------------------------|---------|
| F FH 2005 22 00 | 50 |
| F FH 2007 22 00 | 75 |
| F FH 2010 22 00 | 100-125 |
| F FH 2015 22 00 | 150-175 |
| F FH 2020 22 00 | 200-250 |

Set including:
4 Plain partitions 610 mm

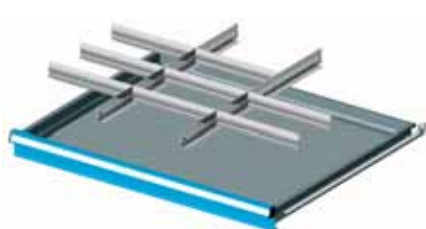

ORD. NO. FOR FRONT HEIGHTS

| | |
|------------------------|---------|
| F FH 3010 02 00 | 100-125 |
| F FH 3015 02 00 | 150-175 |
| F FH 3020 02 00 | 200-250 |
| F FH 3030 02 00 | 300 |

Set including:
2 Slotted partitions 610 mm
8 Plain partitions 251 mm

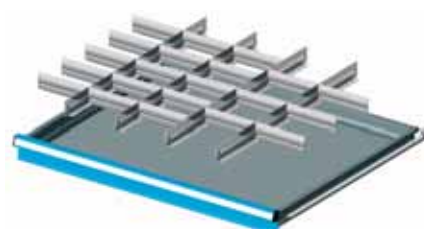

ORD. NO. FOR FRONT HEIGHTS

| | |
|------------------------|---------|
| F FH 3007 03 00 | 75 |
| F FH 3010 03 00 | 100-125 |
| F FH 3015 03 00 | 150-175 |
| F FH 3020 03 00 | 200-250 |
| F FH 3030 03 00 | 300 |

Set including:
4 Slotted partitions 610 mm
21 Plain partitions 149 mm

RAL 7000 F... ..01

RAL 6011 F... ..02

RAL 5012 F... ..04

RAL 7035 F... ..08

KEY ■

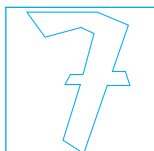

■ Partitioning material: see page A180

■ The handles can be fitted towards the bottom thereby reducing the height by 38 mm.



■ All indicated loads are net and refer to evenly distributed weights



LENGTH = 870 mm DEPTH = 726 mm (45x36 Eh)

CABINETS SERIES STANDARD GG

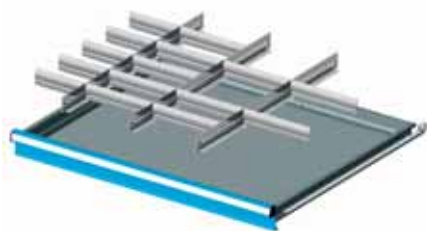

| ORD. NO. | FOR FRONT HEIGHTS |
|------------------------|-------------------|
| F FH 3007 04 00 | 75 |
| F FH 3010 04 00 | 100-125 |
| F FH 3015 04 00 | 150-175 |
| F FH 3020 04 00 | 200-250 |
| F FH 3030 04 00 | 300 |
| Set including: | |
| 3 Slotted partitions | 610 mm |
| 5 Plain partitions | 149 mm |
| 10 Plain partitions | 200 mm |



| ORD. NO. | FOR FRONT HEIGHTS |
|------------------------|-------------------|
| F FH 3005 05 00 | 50 |
| F FH 3007 05 00 | 75 |
| F FH 3010 05 00 | 100-125 |
| Set including: | |
| 5 Slotted partitions | 610 mm |
| 15 Plain partitions | 98 mm |
| 5 Plain partitions | 149 mm |

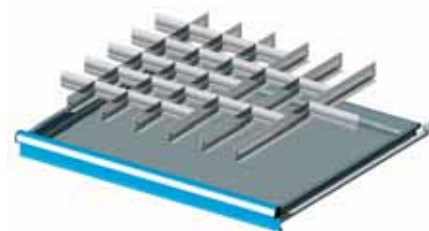

| ORD. NO. | FOR FRONT HEIGHTS |
|------------------------|-------------------|
| F FH 3005 06 00 | 50 |
| F FH 3007 06 00 | 75 |
| F FH 3010 06 00 | 100-125 |
| Set including: | |
| 6 Slotted partitions | 610 mm |
| 24 Plain partitions | 98 mm |
| 1 Plain partition | 149 mm |

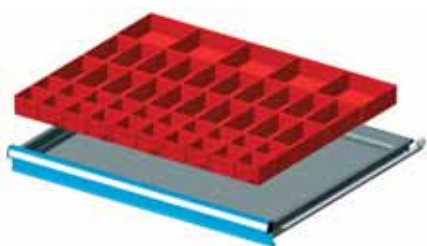

| ORD. NO. | FOR FRONT HEIGHTS |
|------------------------|-------------------|
| F FH 3005 07 00 | 50 |
| F FH 3007 07 00 | 75 |
| Set including: | |
| 20 Plastic boxes | 75x75 mm |
| 20 Plastic boxes | 150x75 mm |
| 5 Plastic boxes | 150x150 mm |

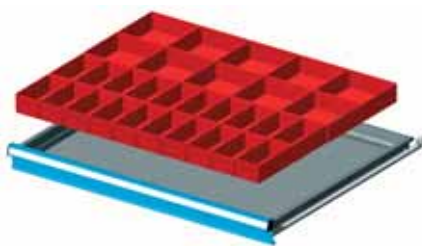

| ORD. NO. | FOR FRONT HEIGHTS |
|------------------------|-------------------|
| F FH 3005 08 00 | 50 |
| F FH 3007 08 00 | 75 |
| F FH 3010 08 00 | 100-125 |
| Set including: | |
| 20 Plastic boxes | 150x75 mm |
| 10 Plastic boxes | 150x150 mm |

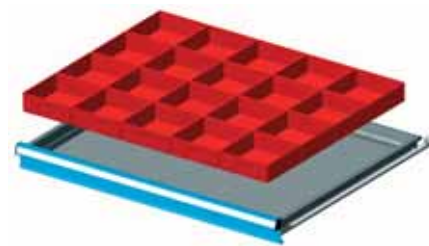

| ORD. NO. | FOR FRONT HEIGHTS |
|------------------------|-------------------|
| F FH 3005 09 00 | 50 |
| F FH 3007 09 00 | 75 |
| F FH 3010 09 00 | 100-125 |
| Set including: | |
| 20 Plastic boxes | 150x150 mm |

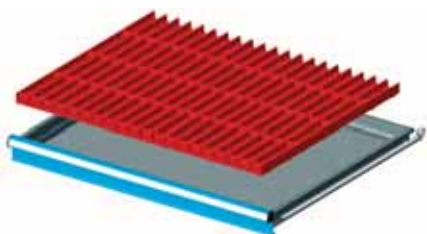

| ORD. NO. | FOR FRONT HEIGHTS |
|------------------------|-------------------|
| F FH 3005 10 00 | 50-300 |
| Set including: | |
| 20 Troughs | 4 grooves |
| 135 Plain partitions | 36 mm |

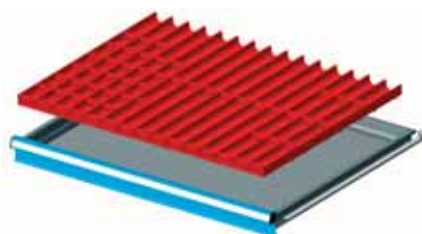

| ORD. NO. | FOR FRONT HEIGHTS |
|------------------------|-------------------|
| F FH 3005 12 00 | 50-300 |
| Set including: | |
| 20 Troughs | 3 grooves |
| 100 Plain partitions | 47 mm |

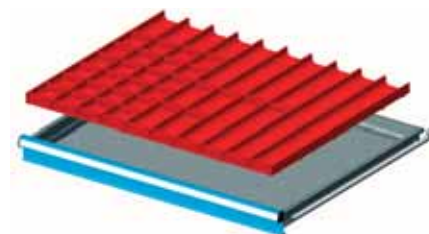

| ORD. NO. | FOR FRONT HEIGHTS |
|------------------------|-------------------|
| F FH 3005 14 00 | 50-300 |
| Set including: | |
| 20 Troughs | 2 grooves |
| 70 Plain partitions | 73 mm |

■ INFO

www.famispa.com

■ Partitioning material: see page A180

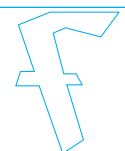



ORD. NO. F AG 4040 S1 08
RAL 7035

ORD. NO. F AG L434 04 2Y
RAL 3020

54 EH (906 mm)

27 EH (447 mm)

FLOOR FIXING SET



2x

- 2 "HILTI" plugs for concrete floors \geq to classes B25/RBK250/MPa 25 N/mm²
- Recommended traction of the plug: 2.9 KN
- Plug diameter: \varnothing 6 mm

ORD. NO. F AG 9204 00 99

CABINET FLOOR FIXING SET

- Pair of spare galvanised brackets
- \varnothing 6 mm hole



ORD. NO. F AG 9200 00 99

CABINET

ORD. NO.

F AG 4040 S1 08

Complete with 6 drawers,
1 MDF top with rubber covering

Dimensions mm 1023x573x1030 h

Tools and partitioning material
excluded

CABINET WITH WHEELS

ORD. NO.

F AG L434 04 2Y

Complete with 5 drawers

Dimensions mm
1098x574x1121 h

RAL 7000 F..01

RAL 6011 F..02

RAL 5012 F..04

RAL 7035 F..08

SUPPLEMENTARY PARTS ■

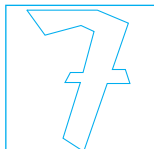

- Partitioning material: see page A113



- **Spare key.** Always indicate the number on the cylinder lock of the key to be replaced.

ORD. NO. R CSC 0002 00

- **Master key.** This type of key opens all the 45 and 46 series locks.

ORD. NO. R CSC 0001 00



LENGTH = 1023 mm DEPTH = 573 mm (54x27 Eh)

CABINETS SERIES STANDARD GF



| ORD. NO. | TYPE |
|-------------------------------------|------|
| F AG 4034 01 04 | A |
| F AG 4034 51 04 | B |
| Cabinet with 5 drawers | |
| Dim. mm 1023x573x850 h Central lock | |

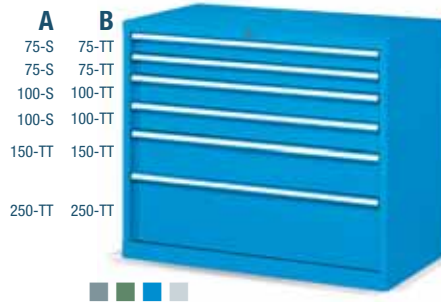

| ORD. NO. | TYPE |
|-------------------------------------|------|
| F AG 4034 02 04 | A |
| F AG 4034 52 04 | B |
| Cabinet with 6 drawers | |
| Dim. mm 1023x573x850 h Central lock | |

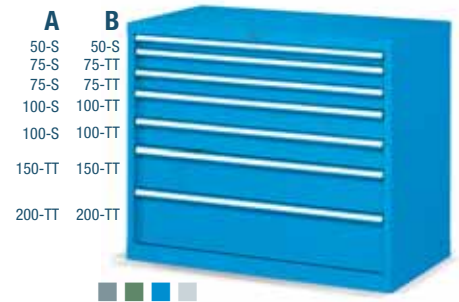

| ORD. NO. | TYPE |
|-------------------------------------|------|
| F AG 4034 03 04 | A |
| F AG 4034 53 04 | B |
| Cabinet with 7 drawers | |
| Dim. mm 1023x573x850 h Central lock | |

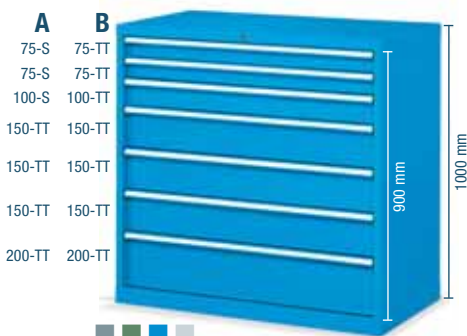

| ORD. NO. | TYPE |
|--------------------------------------|------|
| F AG 4040 06 04 | A |
| F AG 4040 56 04 | B |
| Cabinet with 7 drawers | |
| Dim. mm 1023x573x1000 h Central lock | |

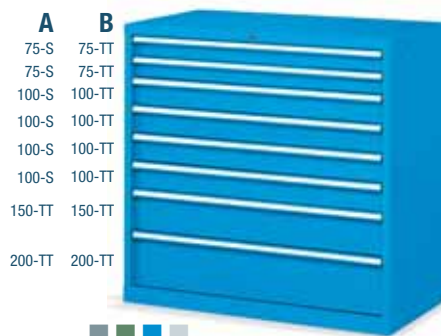

| ORD. NO. | TYPE |
|--------------------------------------|------|
| F AG 4040 02 04 | A |
| F AG 4040 52 04 | B |
| Cabinet with 8 drawers | |
| Dim. mm 1023x573x1000 h Central lock | |

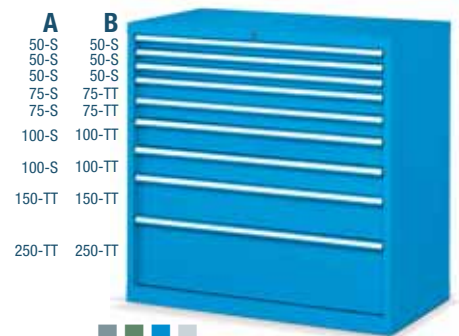

| ORD. NO. | TYPE |
|--------------------------------------|------|
| F AG 4040 03 04 | A |
| F AG 4040 53 04 | B |
| Cabinet with 9 drawers | |
| Dim. mm 1023x573x1000 h Central lock | |

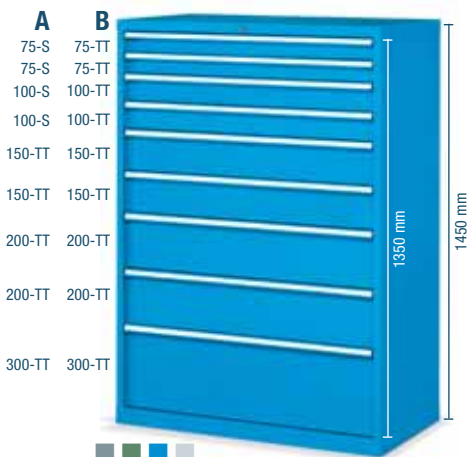

| ORD. NO. | TYPE |
|--|------|
| F AG 4058 01 04 | A |
| F AG 4058 51 04 | B |
| Cabinet with 9 drawers | |
| Dimensions mm 1023x573x1450 h Central lock | |

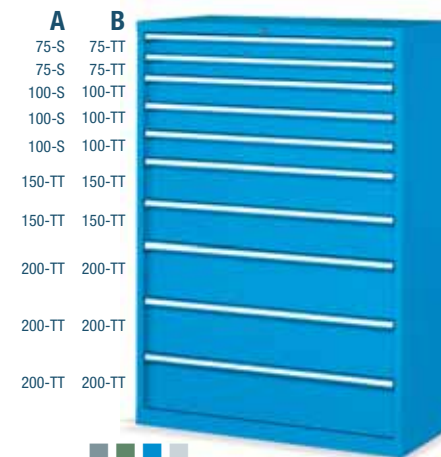

| ORD. NO. | TYPE |
|--|------|
| F AG 4058 05 04 | A |
| F AG 4058 55 04 | B |
| Cabinet with 10 drawers | |
| Dimensions mm 1023x573x1450 h Central lock | |

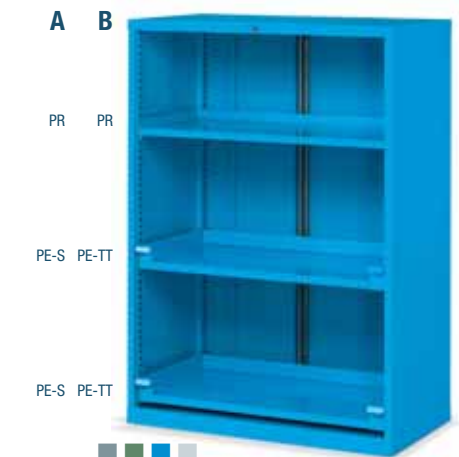

| ORD. NO. | TYPE |
|--|------|
| F AG 4058 08 04 | A |
| F AG 4058 58 04 | B |
| Cabinet with 2 retractable shelves, 1 adjust. shelf | |
| Dimensions mm 1023x573x1450 h Without lock, with anti-tilt rod | |

KEY



- TT = telescopic full extension (100%)
- PE-TT = full telescopic retractable shelf (100%)
- S = normal extension (87%)
- PE-S = normal retractable shelf (87%)
- PR = height adjustable shelf

- RAL 7000 F... ..01
- RAL 6011 F... ..02
- RAL 5012 F... ..04
- RAL 7035 F... ..08

The cabinets must be secured to the floor or to the wall

Partitioning material: see page A113

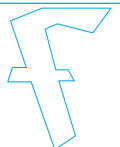

LENGTH = 1023 mm DEPTH = 573 mm (54x27 Eh)

CABINETS SERIES STANDARD GF



| ORD. NO. | TYPE |
|--------------------------------------|----------|
| — | |
| F AG S434 53 04 | B |
| Cabinet with 4 drawers | |
| Cabinet load capacity: 370 kg | |
| Ø 125 mm elastic rubber wheels | |
| Dimensions mm 1098x574x1077 h | |
| Central lock | |

| ORD. NO. | TYPE |
|--------------------------------------|----------|
| F AG S434 04 04 | A |
| F AG S434 54 04 | B |
| Cabinet with 5 drawers | |
| Cabinet load capacity: 370 kg | |
| Ø 125 mm elastic rubber wheels | |
| Dimensions mm 1098x574x1077 h | |
| Central lock | |

| ORD. NO. | TYPE |
|--------------------------------------|----------|
| F AG S434 05 04 | A |
| F AG S434 55 04 | B |
| Cabinet with 6 drawers | |
| Cabinet load capacity: 370 kg | |
| Ø 125 mm elastic rubber wheels | |
| Dimensions mm 1098x574x1077 h | |
| Central lock | |



| ORD. NO. | TYPE |
|--------------------------------------|----------|
| F AG S440 01 04 | A |
| F AG S440 51 04 | B |
| Cabinet with 6 drawers | |
| Cabinet load capacity: 370 kg | |
| Ø 125 mm elastic rubber wheels | |
| Dimensions mm 1098x574x1227 h | |
| Central lock | |

| ORD. NO. | TYPE |
|--------------------------------------|----------|
| F AG S440 02 04 | A |
| F AG S440 52 04 | B |
| Cabinet with 7 drawers | |
| Cabinet load capacity: 370 kg | |
| Ø 125 mm elastic rubber wheels | |
| Dimensions mm 1098x574x1227 h | |
| Central lock | |

RAL 7000 F... ..01 RAL 6011 F... ..02 RAL 5012 F... ..04 RAL 7035 F... ..08

KEY ■

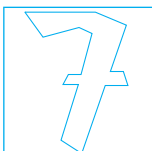

■ Partitioning material: see page A113

■ The handles can be fitted towards the bottom thereby reducing the height by 38 mm.



- TT = telescopic full extension (100%)
- S = normal extension (87%)
- All indicated loads are net and refer to evenly distributed weights



LENGTH = 1023 mm DEPTH = 573 mm (54x27 Eh)

CABINETS SERIES STANDARD GF

CABINET WITH WHEELS**ORD. NO.****F AG L434 S1 2Y**complete with 5 drawers,
1 MDF top with rubber covering**Dimensions mm 1098x574x1091 h**

Tools and partitioning material excluded



■ RAL 3020



■ RAL 7035

CABINET**ORD. NO.****F AG 4040 S2 08**

6 drawers

1 rubber cover top with 3 edges

1 plinth for transpallet

Dimensions mm 1023x573x1120 h

Tools and partitioning material excluded

■ **INFO**

RAL 7000 F... ..01

RAL 6011 F... ..02

RAL 5012 F... ..04

RAL 7035 F... ..08

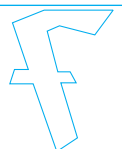
■ Partitioning
material: see
page **A180**www.famispa.com

CABINETS SERIES STANDARD GF

EMPTY CABINETS

| ORD. NO. | USABLE HEIGHT mm | LOAD CAPACITY kg | DIMENSIONS mm |
|-----------------|------------------|------------------|-----------------|
| F AG 4034 00 04 | 750 | 3100 | 1023x573x850 h |
| F AG 4040 00 04 | 900 | 3100 | 1023x573x1000 h |
| F AG 4058 00 04 | 1350 | 3100 | 1023x573x1450 h |



SPARE LOCK
ORD. NO. R CSR 0003 00
for cabinet

■ 01 ■ 02 ■ 04 ■ 08

■ The cabinets must be secured to the floor or to the wall. If the cabinets are stacked they must be secured to the wall and their load capacity must be divided by 2. Further information for fixing set see page A106.

NORMAL EXTENSION DRAWERS (S)

| ORD. NO. | FRONT HEIGHT mm | LOAD CAPACITY kg | USABLE DIMENSIONS mm |
|-----------------|-----------------|------------------|----------------------|
| F FG 4005 00 04 | 50 | 60 | 906x447x36 h |
| F FG 4007 00 04 | 75 | 80 | 906x447x61 h |
| F FG 4010 00 04 | 100 | 100 | 906x447x86 h |
| F FG 4012 00 04 | 125 | 100 | 906x447x111 h |

Normal extension (87%)



■ 01
■ 02
■ 04
■ 08

Partitioning material: see page A113

FULL TELESCOPIC EXTENSION DRAWERS (TT)

| ORD. NO. | FRONT HEIGHT mm | LOAD CAPACITY kg | USABLE DIMENSIONS mm |
|-----------------|-----------------|------------------|----------------------|
| F FG 4107 00 04 | 75 | 150 | 906x447x54 h |
| F FG 4110 00 04 | 100 | 150 | 906x447x79 h |
| F FG 4112 00 04 | 125 | 150 | 906x447x104 h |
| F FG 4115 00 04 | 150 | 150 | 906x447x129 h |
| F FG 4120 00 04 | 200 | 150 | 906x447x179 h |
| F FG 4125 00 04 | 250 | 150 | 906x447x229 h |
| F FG 4130 00 04 | 300 | 150 | 906x447x279 h |

Full telescopic extension (100%)



■ 01
■ 02
■ 04
■ 08

■ Partitioning material: see page A113

NORMAL EXTENSION SHELVES (PE-S)

| ORD. NO. | SIDE HEIGHT mm | LOAD CAPACITY kg | USABLE DIMENSIONS mm |
|-----------------|----------------|------------------|----------------------|
| F FG 8040 00 04 | - | 100 | 916x457 |

Normal extension (87%)



■ 01
■ 02
■ 04
■ 08

FULL TELESCOPIC EXTENSION SHELVES (PE-TT)

| ORD. NO. | SIDE HEIGHT mm | LOAD CAPACITY kg | USABLE DIMENSIONS mm |
|-----------------|----------------|------------------|----------------------|
| F FG 8140 00 04 | - | 150 | 916x457 |

Full telescopic extension (100%)



■ 01
■ 02
■ 04
■ 08

ADJUSTABLE SHELVES

| ORD. NO. | SIDE HEIGHT mm | LOAD CAPACITY kg | USABLE DIMENSIONS mm |
|-----------------|----------------|------------------|----------------------|
| F SR 1220 01 04 | 25 | 100 | 967x465 |

Without extension system



■ 01
■ 02
■ 04
■ 08

RAL 7000 F.01 RAL 6011 F.02 RAL 5012 F.04 RAL 7035 F.08

KEY

■ All indicated loads are net and refer to evenly distributed weights



LENGTH = 1023 mm DEPTH = 573 mm (54x27 Eh)

CABINETS SERIES STANDARD GF

CABINET TO CABINET FIXING

■ The article includes:
4 M8 nuts and bolts

ORD. NO. F AG 9202 00 99

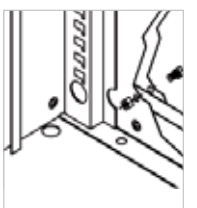

TWO SIDED ADHESIVE TAPE

ORD. NO.

R CMV 0025 00

width 15 mm, length 50 metres



■ 07

TOP SHELF

ORD. NO.

DIMENSIONS mm

F AG 9009 01 07

1023x573x20 h

oil-resistant rubber cover top with 3 edges



■ 07

PLINTHS

ORD. NO.

F RR 0090 00 07

Plinths height 50 mm



■ 07

PLINTHS FOR TRANSPALLET

ORD. NO.

F RR 0205 00 07 Plinths height 100 mm

F RR 0415 00 07 Facing piece



■ 07

PLINTHS FOR FORK LIFT TRUCK

ORD. NO.

F RR 0200 00 07 Pair of plinths height 60 mm

F RR 0410 00 07 Facing piece

UPPER MDF TOP WITH RUBBER COVERING DIMENSIONS 1024x573x31,5 mm H

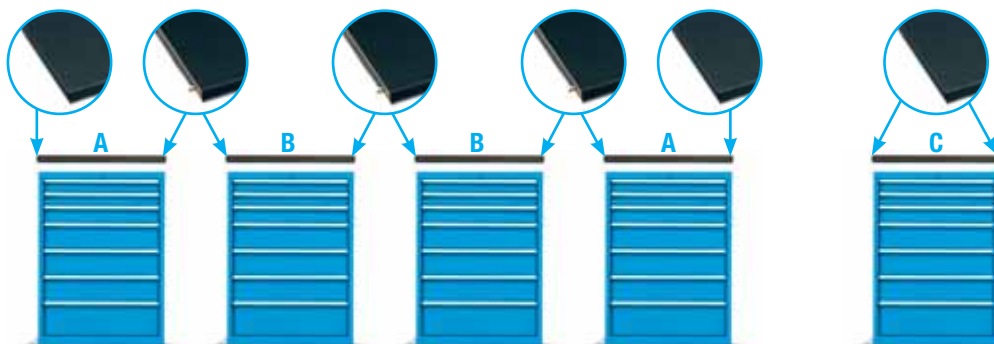

ORD. NO. F UZ 9999 00 00

Drilling of the cabinet upper shelf for the MDF top fixing.



Detail of the oil-resistant rubber



■ 07

A

ORD. NO.

F UZ 3090 11 07

MDF top with rubber covering

Side profile

For end cabinets

Oil-resistant rubber mat



■ 07

B

ORD. NO.

F UZ 3090 12 07

MDF top with rubber covering

No side profile

For additional central cabinets Oil-resist. rubber mat



■ 07

C

ORD. NO.

F UZ 3090 13 07

MDF top with rubber covering

2 side profiles

For single cabinet

Oil-resistant rubber mat

■ INFO

RAL 7000 F... ..01

RAL 6011 F... ..02

RAL 5012 F... ..04

RAL 7035 F... ..08



www.famispa.com



CABINETS SERIES STANDARD GF

CABINETS PREPARED FOR WHEELS

Cabinets prepared for wheels including: wheel plate, 4 edged top with oil-resistant rubber, 2 steel handles covered with shock-resistant rubber, cylinder lock with 2 keys, anti-tilt rod.

- 01
- 02
- 04
- 08



- 01
- 02
- 04
- 08



■ The single drawer opening system **ORD. NO. F DD 9400 00 07** must be applied to all drawers of mobile cabinets.

ORD. NO.

F AG 0434 00 04

Overall dim. mm:
1098x574x917 h without wheels

*Wheel plate thickness

ORD. NO.

F AG 0440 00 04

Overall dim. mm:
1098x574x1067 h without wheels

*Wheel plate thickness

■ Other types of wheels see page **A52**



ELASTIC RUBBER SWIVEL WHEEL WITH BRAKE

| ORD. NO. | Ø mm | CABINET LOAD CAPACITY | C mm |
|-----------------------|------|-----------------------|------|
| C RG DCE15 125 | 125 | 370 kg | 160 |



ELASTIC RUBBER FIXED WHEEL

| ORD. NO. | Ø mm | CABINET LOAD CAPACITY | C mm |
|-----------------------|------|-----------------------|------|
| C RG BCE15 125 | 125 | 370 kg | 160 |



NYLON SWIVEL WHEEL WITH BRAKE

| ORD. NO. | Ø mm | CABINET LOAD CAPACITY | C mm |
|-----------------------|------|-----------------------|------|
| C RN DAD11 125 | 125 | 370 kg | 160 |



NYLON FIXED WHEEL

| ORD. NO. | Ø mm | CABINET LOAD CAPACITY | C mm |
|-----------------------|------|-----------------------|------|
| C RN BAD11 125 | 125 | 370 kg | 160 |

RAL 7000 F... ..01

RAL 6011 F... ..02

RAL 5012 F... ..04

RAL 7035 F... ..08

KEY ■

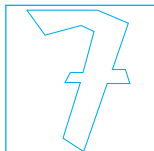

■ The handles can be fitted towards the bottom thereby reducing the height by 38 mm.



■ All indicated loads are net and refer to evenly distributed weights



LENGTH = 1023 mm DEPTH = 573 mm (54x27 Eh)

CABINETS SERIES STANDARD GF

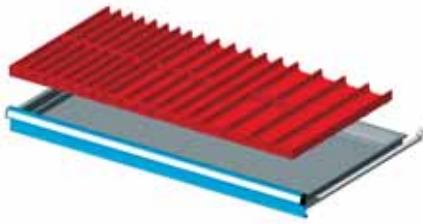

| ORD. NO. | FOR FRONT HEIGHTS |
|------------------------|-------------------|
| F FH 4005 12 00 | 50-300 |
| Set including: | |
| 6 Troughs | 4 grooves |
| 15 Plain partitions | 36 mm |
| 6 Troughs | 3 grooves |
| 10 Plain partitions | 47 mm |
| 6 Troughs | 2 grooves |
| 6 Plain partitions | 73 mm |

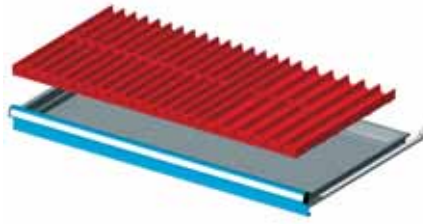

| ORD. NO. | FOR FRONT HEIGHTS |
|------------------------|-------------------|
| F FH 4005 15 00 | 50-300 |
| Set including: | |
| 12 Troughs | 4 grooves |
| 30 Plain partitions | 36 mm |
| 6 Troughs | 3 grooves |
| 10 Plain partitions | 47 mm |



| ORD. NO. | FOR FRONT HEIGHTS |
|------------------------|-------------------|
| F FH 4005 01 00 | 50 |
| F FH 4007 01 00 | 75 |
| F FH 4010 01 00 | 100-125 |
| F FH 4015 01 00 | 150-175 |
| F FH 4020 01 00 | 200-250 |
| F FH 4030 01 00 | 300 |
| Set including: | |
| 2 Plain partitions | 914 mm |

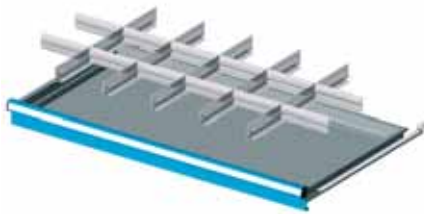

| ORD. NO. | FOR FRONT HEIGHTS |
|------------------------|-------------------|
| F FH 4005 03 00 | 50 |
| F FH 4007 03 00 | 75 |
| F FH 4010 03 00 | 100-125 |
| F FH 4015 03 00 | 150-175 |
| F FH 4020 03 00 | 200-250 |
| Set including: | |
| 5 Slotted partitions | 455 mm |
| 12 Plain partitions | 149 mm |

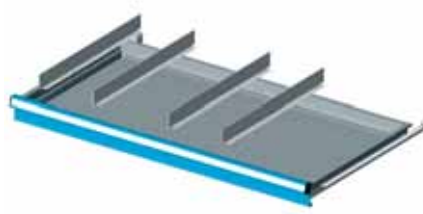

| ORD. NO. | FOR FRONT HEIGHTS |
|------------------------|-------------------|
| F FH 4005 04 00 | 50 |
| F FH 4007 04 00 | 75 |
| F FH 4010 04 00 | 100-125 |
| F FH 4015 04 00 | 150-175 |
| F FH 4020 04 00 | 200-250 |
| Set including: | |
| 4 Plain partitions | 455 mm |

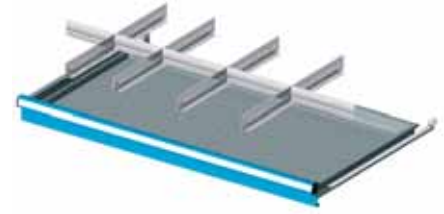

| ORD. NO. | FOR FRONT HEIGHTS |
|------------------------|-------------------|
| F FH 4005 05 00 | 50 |
| F FH 4007 05 00 | 75 |
| F FH 4010 05 00 | 100-125 |
| F FH 4015 05 00 | 150-175 |
| F FH 4020 05 00 | 200-250 |
| Set including: | |
| 4 Slotted partitions | 455 mm |
| 2 Plain partitions | 149 mm |
| 3 Plain partitions | 200 mm |

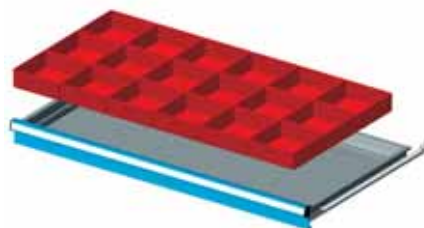

| ORD. NO. | FOR FRONT HEIGHTS |
|------------------------|-------------------|
| F FH 4005 11 00 | 50 |
| F FH 4007 11 00 | 75 |
| F FH 4010 11 00 | 100-125 |
| Set including: | |
| 18 Plastic boxes | 150x150 mm |

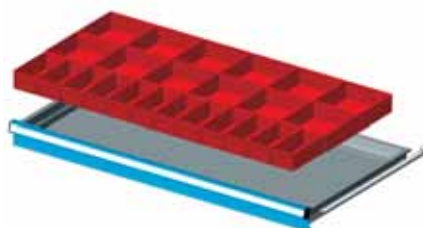

| ORD. NO. | FOR FRONT HEIGHTS |
|------------------------|-------------------|
| F FH 4005 13 00 | 50 |
| F FH 4007 13 00 | 75 |
| F FH 4010 13 00 | 100-125 |
| Set including: | |
| 12 Plastic boxes | 150x75 mm |
| 12 Plastic boxes | 150x150 mm |

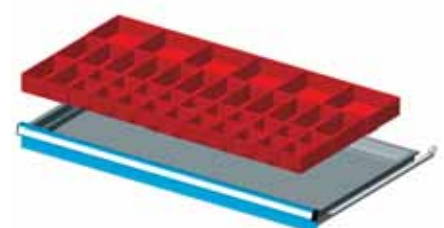

| ORD. NO. | FOR FRONT HEIGHTS |
|------------------------|-------------------|
| F FH 4005 16 00 | 50 |
| F FH 4007 16 00 | 75 |
| Set including: | |
| 20 Plastic boxes | 75x75 mm |
| 14 Plastic boxes | 150x75 mm |
| 6 Plastic boxes | 150x150 mm |

■ INFO

www.famispa.com

■ Partitioning material: see page A180

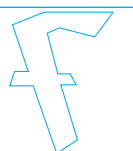



ORD. NO. F AG 5040 S1 08
RAL 7035

ORD. NO. F AG L534 S1 50
RAL 7035+5012

54 EH (906 mm)

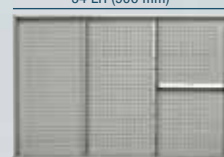

36 EH (600 mm)

FLOOR FIXING SET



2x

- 2 "HILTI" plugs for concrete floors \geq to classes B25/RBK250/MPa 25 N/mm²
- Recommended traction of the plug: 2.9 KN
- Plug diameter: \varnothing 6 mm

ORD. NO. F AG 9204 00 99

CABINET FLOOR FIXING SET

- Pair of spare galvanised brackets
- \varnothing 6 mm hole



ORD. NO. F AG 9200 00 99

CABINET

ORD. NO.

F AG 5040 S1 08

Complete with 6 drawers,
1 rubber cover top with 3 edges

Dimensions mm 1023x726x1020 h

Tools and partitioning material
excluded

CABINET WITH WHEELS

ORD. NO.

F AG L534 S1 50

Complete with 5 drawers,
1 multiplex worktop 40 mm thickness

Dimensions mm 1098x750x1101 h

RAL 7000 F... ..01

RAL 6011 F... ..02

RAL 5012 F... ..04

RAL 7035 F... ..08

SUPPLEMENTARY PARTS ■



- Partitioning material: see page A113



- **Spare key.** Always indicate the number on the cylinder lock of the key to be replaced.

ORD. NO. R CSC 0002 00

- **Master key.** This type of key opens all the 45 and 46 series locks.

ORD. NO. R CSC 0001 00



LENGTH = 1023 mm DEPTH = 726 mm (54x36 Eh)

CABINETS SERIES STANDARD GB



- | | |
|----------|----------|
| A | B |
| 100-S | 100-TT |
| 150-TT | 150-TT |
| 150-TT | 150-TT |
| 150-TT | 150-TT |
| 200-TT | 200-TT |

750 mm
850 mm

| ORD. NO. | TYPE |
|------------------------------|----------|
| F AG 5034 04 04 | A |
| F AG 5034 54 04 | B |
| Cabinet with 5 drawers | |
| Dimensions mm 1023x726x850 h | |
| Central lock | |



- | | |
|----------|----------|
| A | B |
| 100-S | 100-TT |
| 100-S | 100-TT |
| 100-S | 100-TT |
| 150-TT | 150-TT |
| 300-TT | 300-TT |

750 mm
850 mm

| ORD. NO. | TYPE |
|------------------------------|----------|
| F AG 5034 07 04 | A |
| F AG 5034 57 04 | B |
| Cabinet with 5 drawers | |
| Dimensions mm 1023x726x850 h | |
| Central lock | |



- | | |
|----------|----------|
| A | B |
| 75-S | 75-TT |
| 75-S | 75-TT |
| 100-S | 100-TT |
| 100-S | 100-TT |
| 150-TT | 150-TT |
| 250-TT | 250-TT |

750 mm
850 mm



- | | |
|----------|----------|
| A | B |
| 50-S | 50-S |
| 75-S | 75-TT |
| 75-S | 75-TT |
| 100-S | 100-TT |
| 100-S | 100-TT |
| 150-TT | 150-TT |
| 200-TT | 200-TT |

750 mm
850 mm

| ORD. NO. | TYPE |
|------------------------------|----------|
| F AG 5034 08 04 | A |
| F AG 5034 58 04 | B |
| Cabinet with 6 drawers | |
| Dimensions mm 1023x726x850 h | |
| Central lock | |

| ORD. NO. | TYPE |
|------------------------------|----------|
| F AG 5034 09 04 | A |
| F AG 5034 59 04 | B |
| Cabinet with 7 drawers | |
| Dimensions mm 1023x726x850 h | |
| Central lock | |

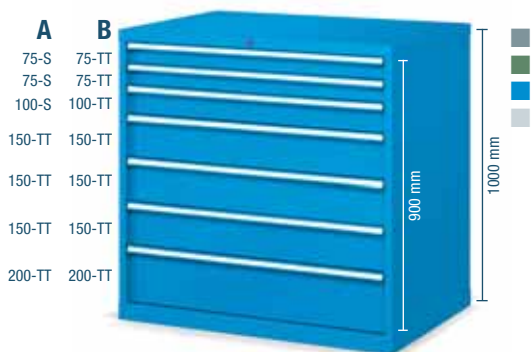

- | | |
|----------|----------|
| A | B |
| 75-S | 75-TT |
| 75-S | 75-TT |
| 100-S | 100-TT |
| 150-TT | 150-TT |
| 150-TT | 150-TT |
| 150-TT | 150-TT |
| 200-TT | 200-TT |

900 mm
1000 mm

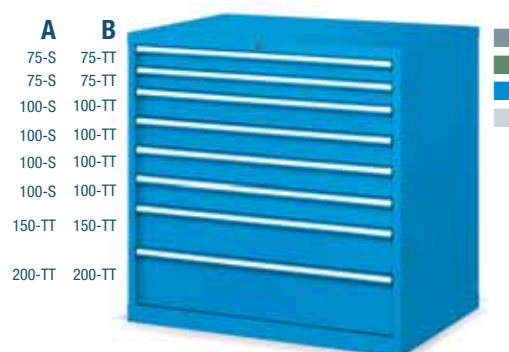

- | | |
|----------|----------|
| A | B |
| 75-S | 75-TT |
| 75-S | 75-TT |
| 100-S | 100-TT |
| 100-S | 100-TT |
| 100-S | 100-TT |
| 100-S | 100-TT |
| 150-TT | 150-TT |
| 200-TT | 200-TT |

900 mm
1000 mm

| ORD. NO. | TYPE |
|-------------------------------|----------|
| F AG 5040 11 04 | A |
| F AG 5040 61 04 | B |
| Cabinet with 7 drawers | |
| Dimensions mm 1023x726x1000 h | |
| Central lock | |

| ORD. NO. | TYPE |
|-------------------------------|----------|
| F AG 5040 05 04 | A |
| F AG 5040 02 04 | B |
| Cabinet with 8 drawers | |
| Dimensions mm 1023x726x1000 h | |
| Central lock | |

KEY



- TT = telescopic full extension (100%)
- S = normal extension (87%)
- All indicated loads are net and refer to evenly distributed weights

■ Partitioning material: see page A113

RAL 7000 F... ..01 RAL 6011 F... ..02 RAL 5012 F... ..04 RAL 7035 F... ..08



LENGTH = 1023 mm DEPTH = 726 mm (54x36 Eh)

CABINETS SERIES STANDARD GB

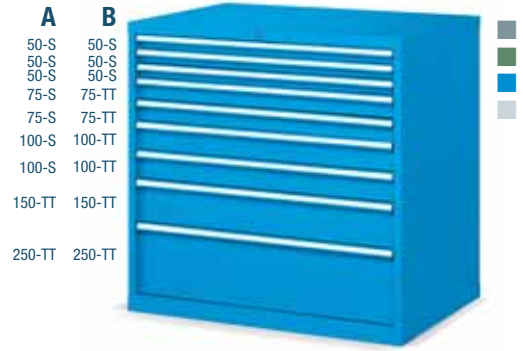
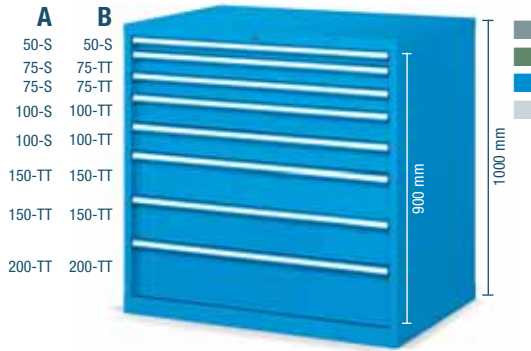

| ORD. NO. | TYPE |
|--------------------------------------|----------|
| F AG 5040 08 04 | A |
| F AG 5040 58 04 | B |
| Cabinet with 8 drawers | |
| Dimensions mm 1023x726x1000 h | |
| Central lock | |

| ORD. NO. | TYPE |
|--------------------------------------|----------|
| F AG 5040 12 04 | A |
| F AG 5040 62 04 | B |
| Cabinet with 9 drawers | |
| Dimensions mm 1023x726x1000 h | |
| Central lock | |



| ORD. NO. | TYPE |
|--------------------------------------|----------|
| F AG 5040 15 04 | A |
| F AG 5040 65 04 | B |
| Cabinet with 2 retractable shelves | |
| Dimensions mm 1023x726x1000 h | |
| Without lock, with anti-tilt rod | |

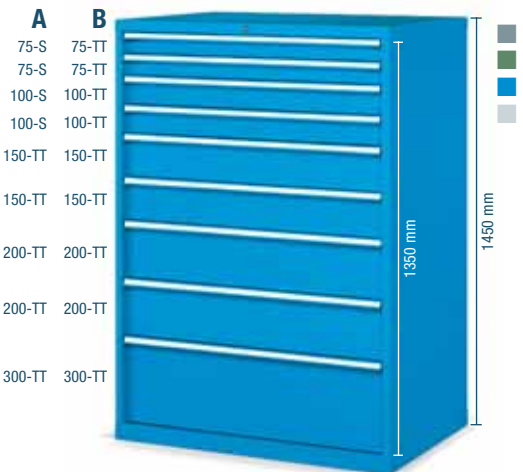
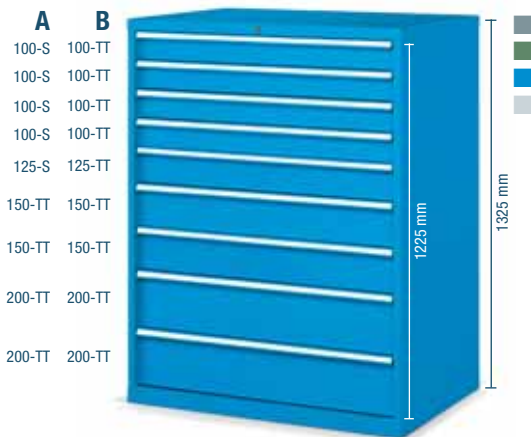

| ORD. NO. | TYPE |
|--------------------------------------|----------|
| F AG 5053 04 04 | A |
| F AG 5053 01 04 | B |
| Cabinet with 9 drawers | |
| Dimensions mm 1023x726x1325 h | |
| Central lock | |

| ORD. NO. | TYPE |
|--------------------------------------|----------|
| F AG 5058 07 04 | A |
| F AG 5058 57 04 | B |
| Cabinet with 9 drawers | |
| Dimensions mm 1023x726x1450 h | |
| Central lock | |

RAL 7000 F... ..01 RAL 6011 F... ..02 RAL 5012 F... ..04 RAL 7035 F... ..08

KEY ■

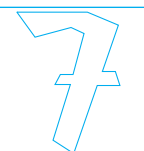

■ Partitioning material: see page A113

- TT = telescopic full extension (100%)
- PE-TT = full telescopic retractable shelf (100%)
- S = normal extension (87%)
- PE-S = normal retractable shelf (87%)
- The cabinets must be secured to the floor or to the wall



LENGTH = 1023 mm DEPTH = 726 mm (54x36 Eh)

CABINETS SERIES STANDARD GB

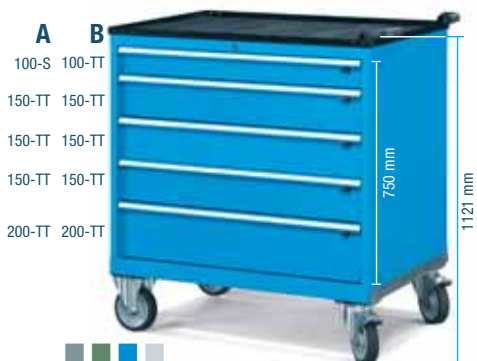

| ORD. NO. | TYPE |
|--------------------------------------|----------|
| F AG L534 02 04 | A |
| F AG L534 52 04 | B |
| Cabinet with 5 drawers | |
| Cabinet load capacity: 600 kg | |
| Ø 160 mm elastic rubber wheels | |
| Dimensions mm 1098x727x1121 h | |
| Central lock | |



| ORD. NO. | TYPE |
|--------------------------------------|----------|
| F AG L534 05 04 | A |
| F AG L534 55 04 | B |
| Cabinet with 6 drawers | |
| Cabinet load capacity: 600 kg | |
| Ø 160 mm elastic rubber wheels | |
| Dimensions mm 1098x727x1121 h | |
| Central lock | |



| ORD. NO. | TYPE |
|--------------------------------------|----------|
| F AG L540 01 04 | A |
| F AG L540 51 04 | B |
| Cabinet with 6 drawers | |
| Cabinet load capacity: 600 kg | |
| Ø 160 mm elastic rubber wheels | |
| Dimensions mm 1098x727x1271 h | |
| Central lock | |



| ORD. NO. | TYPE |
|--------------------------------------|----------|
| F AG L540 02 04 | A |
| F AG L540 52 04 | B |
| Cabinet with 7 drawers | |
| Cabinet load capacity: 600 kg | |
| Ø 160 mm elastic rubber wheels | |
| Dimensions mm 1098x727x1271 h | |
| Central lock | |



CABINET WITH WHEELS

ORD. NO.

F AG L534 S2 50

complete with 5 drawers,
1 multiplex worktop 40 mm thickness,
1 multi-purpose back panel with containers and 2x18W lamp

Dim. mm 1098x750x1041/2068 h Tools and partitioning material excluded

■ RAL 7035 +
■ RAL 5012



- TT = telescopic full extension (100%)
- S = normal extension (87%)
- All indicated loads are net and refer to evenly distributed weights



■ The handles can be fitted towards the bottom thereby reducing the height by 38 mm.

■ Partitioning material: see page A113



KEY

RAL 7000 F... ..01 RAL 6011 F... ..02 RAL 5012 F... ..04 RAL 7035 F... ..08

CABINETS SERIES STANDARD GB

EMPTY CABINETS

| ORD. NO. | USABLE HEIGHT mm | LOAD CAPACITY kg | DIMENSIONS mm |
|-----------------|------------------|------------------|-----------------|
| F AG 5034 00 04 | 750 | 3100 | 1023x726x850 h |
| F AG 5040 00 04 | 900 | 3100 | 1023x726x1000 h |
| F AG 5053 00 04 | 1225 | 3100 | 1023x726x1325 h |
| F AG 5058 00 04 | 1350 | 3100 | 1023x726x1450 h |



SPARE LOCK
ORD. NO. R CSR 0003 00
for cabinet

■ 01 ■ 02 ■ 04 ■ 08

■ The cabinets must be secured to the floor or to the wall. If the cabinets are stacked they must be secured to the wall and their load capacity must be divided by 2. Further information for fixing set see page A114.

NORMAL EXTENSION DRAWERS (S)

| ORD. NO. | FRONT HEIGHT mm | LOAD CAPACITY kg | USABLE DIMENSIONS mm |
|-----------------|-----------------|------------------|----------------------|
| F FG 5005 00 04 | 50 | 60 | 906x600x36 h |
| F FG 5007 00 04 | 75 | 80 | 906x600x61 h |
| F FG 5010 00 04 | 100 | 100 | 906x600x86 h |
| F FG 5012 00 04 | 125 | 100 | 906x600x111 h |

Normal extension (87%)



■ 01
■ 02
■ 04
■ 08

■ Partitioning material: see page A121

FULL TELESCOPIC EXTENSION DRAWERS (TT)

| ORD. NO. | FRONT HEIGHT mm | LOAD CAPACITY kg | USABLE DIMENSIONS mm |
|-----------------|-----------------|------------------|----------------------|
| F FG 5107 00 04 | 75 | 150 | 906x600x54 h |
| F FG 5110 00 04 | 100 | 150 | 906x600x79 h |
| F FG 5112 00 04 | 125 | 150 | 906x600x104 h |
| F FG 5115 00 04 | 150 | 150 | 906x600x129 h |
| F FG 5117 00 04 | 175 | 150 | 906x600x154 h |
| F FG 5120 00 04 | 200 | 150 | 906x600x179 h |
| F FG 5125 00 04 | 250 | 150 | 906x600x229 h |
| F FG 5130 00 04 | 300 | 150 | 906x600x279 h |

Full telescopic extension (100%)



■ 01
■ 02
■ 04
■ 08

■ Partitioning material: see page A121

NORMAL EXTENSION SHELVES (PE-S)

| ORD. NO. | SIDE HEIGHT mm | LOAD CAPACITY kg | USABLE DIMENSIONS mm |
|-----------------|----------------|------------------|----------------------|
| F FG 8050 00 04 | – | 100 | 916x610 |

Normal extension (87%)



■ 01
■ 02
■ 04
■ 08

FULL TELESCOPIC EXTENSION SHELVES (PE-TT)

| ORD. NO. | SIDE HEIGHT mm | LOAD CAPACITY kg | USABLE DIMENSIONS mm |
|-----------------|----------------|------------------|----------------------|
| F FG 8150 00 04 | – | 150 | 916x610 |

Full telescopic extension (100%)



■ 01
■ 02
■ 04
■ 08

ADJUSTABLE SHELVES

| ORD. NO. | SIDE HEIGHT mm | LOAD CAPACITY kg | USABLE DIMENSIONS mm |
|-----------------|----------------|------------------|----------------------|
| F SR 1270 01 04 | 25 | 100 | 967x618 |

Without extension system



■ 01
■ 02
■ 04
■ 08

RAL 7000 F.01

RAL 6011 F.02

RAL 5012 F.04

RAL 7035 F.08

KEY ■

■ All indicated loads are net and refer to evenly distributed weights



LENGTH = 1023 mm DEPTH = 726 mm (54x36 Eh)

CABINETS SERIES STANDARD GB

CABINET TO CABINET FIXING

■ The article includes:
4 M8 nuts and bolts

ORD. NO. F AG 9202 00 99

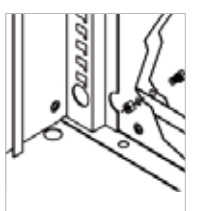

TWO SIDED ADHESIVE TAPE

ORD. NO.

R CMV 0025 00

width 15 mm, length 50 metres



TOP SHELF

ORD. NO.

F AG 9012 01 07

DIMENSIONS mm

1023x726x20 h

oil-resistant rubber cover top with 3 edges



PLINTHS

ORD. NO.

F RR 0095 00 07

Plinths height 50 mm



PLINTHS FOR TRANSPALLET

ORD. NO.

F RR 0235 00 07 Plinths height 100 mm

F RR 0415 00 07 Facing piece



PLINTHS FOR FORK LIFT TRUCK

ORD. NO.

F RR 0230 00 07 Pair of plinths height 60 mm

F RR 0410 00 07 Facing piece

UPPER MDF TOP WITH RUBBER COVERING DIMENSIONS 1024x726x31,5 mm H

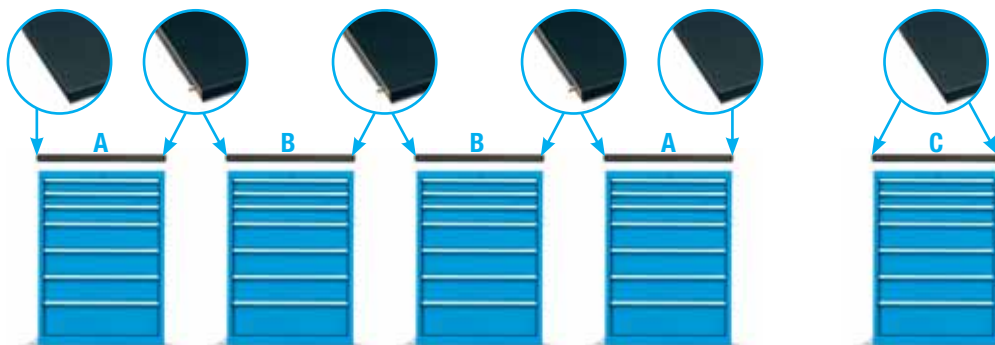

ORD. NO. F UZ 9999 00 00

Drilling of the cabinet upper shelf for the MDF top fixing.



Detail of the oil-resistant rubber

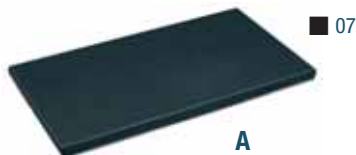

ORD. NO.

F UZ 3240 11 07

MDF top with rubber covering

Side profile

For end cabinets

Oil-resistant rubber mat



ORD. NO.

F UZ 3240 12 07

MDF top with rubber covering

No side profile

For additional central cabinets Oil-resist. rubber mat

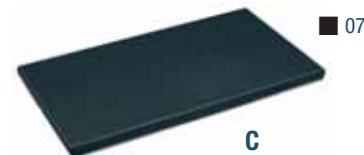

ORD. NO.

F UZ 3240 13 07

MDF top with rubber covering

2 side profiles

For single cabinet

Oil-resistant rubber mat

■ INFO

RAL 7000 F... ..01 RAL 6011 F... ..02 RAL 5012 F... ..04 RAL 7035 F... ..08



www.famispa.com



CABINETS SERIES STANDARD GB

CABINETS PREPARED FOR WHEELS

Cabinets prepared for wheels including: wheel plate, 4 edged top with oil-resistant rubber, 2 steel handles covered with shock-resistant rubber, cylinder lock with 2 keys, anti-tilt rod.



- 01
- 02
- 04
- 08



- 01
- 02
- 04
- 08

■ The single drawer opening system **ORD. NO. F DD 9400 00 07** must be applied to all drawers of mobile cabinets.

ORD. NO.
F AG 0534 00 04
 Overall dim. mm:
1098x727x917 h senza ruote
 *Wheel plate thickness

ORD. NO.
F AG 0540 00 04
 Overall dim. mm:
1098x727x1067 h senza ruote
 *Wheel plate thickness

■ Other types of wheels see page A52

ELASTIC RUBBER SWIVEL WHEEL WITH BRAKE
ORD. NO. _____ **Ø mm** _____ **CABINET LOAD CAPACITY** _____ **C mm** _____
C RG DCE15 160 160 600 kg 204

ELASTIC RUBBER FIXED WHEEL
ORD. NO. _____ **Ø mm** _____ **CABINET LOAD CAPACITY** _____ **C mm** _____
C RG BCE15 160 160 600 kg 204

NYLON SWIVEL WHEEL WITH BRAKE
ORD. NO. _____ **Ø mm** _____ **CABINET LOAD CAPACITY** _____ **C mm** _____
C RN DAD04 160 160 600 kg 204

NYLON FIXED WHEEL
ORD. NO. _____ **Ø mm** _____ **CABINET LOAD CAPACITY** _____ **C mm** _____
C RN BAD04 160 160 600 kg 204

EXAMPLE INCLUDING:

ORD. NO.
F AG 5053 58 50
 2 retractable shelves
Dimensions mm 1023x726x1325 h
 Polypropylene stacking containers excluded



- RAL 7035 +
- RAL 5012

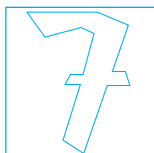

■ Partitioning material: see page A180

■ The handles can be fitted towards the bottom thereby reducing the height by 38 mm.

■ All indicated loads are net and refer to evenly distributed weights



LENGTH = 1023 mm DEPTH = 726 mm (54x36 Eh)

CABINETS SERIES STANDARD GB

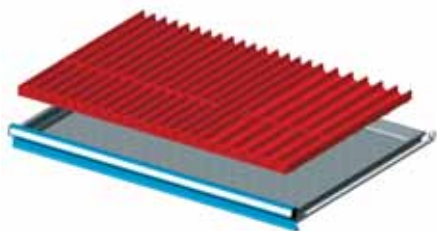

| ORD. NO. | FOR FRONT HEIGHTS |
|----------|-------------------|
|----------|-------------------|

| | |
|------------------------|-----------|
| F FH 5005 19 00 | 50-300 |
| Set including: | |
| 16 Troughs | 4 grooves |
| 30 Plain partitions | 36 mm |
| 8 Troughs | 3 grooves |
| 10 Plain partitions | 47 mm |

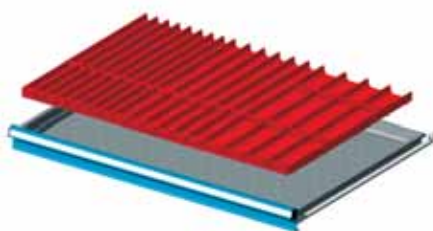

| ORD. NO. | FOR FRONT HEIGHTS |
|----------|-------------------|
|----------|-------------------|

| | |
|------------------------|-----------|
| F FH 5005 09 00 | 50-300 |
| Set including: | |
| 8 Troughs | 4 grooves |
| 15 Plain partitions | 36 mm |
| 8 Troughs | 3 grooves |
| 10 Plain partitions | 47 mm |
| 8 Troughs | 2 grooves |
| 6 Plain partitions | 73 mm |

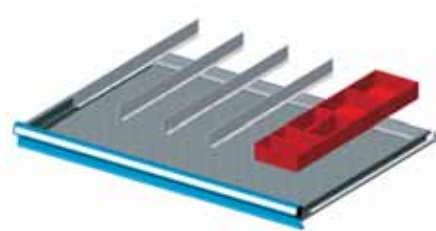

| ORD. NO. | FOR FRONT HEIGHTS |
|----------|-------------------|
|----------|-------------------|

| | |
|------------------------|------------|
| F FH 5005 05 00 | 50 |
| F FH 5007 05 00 | 75 |
| F FH 5010 05 00 | 100-125 |
| Set including: | |
| 5 Plain partitions | 610 mm |
| 4 Plastic boxes | 150x75 mm |
| 2 Plastic boxes | 150x150 mm |

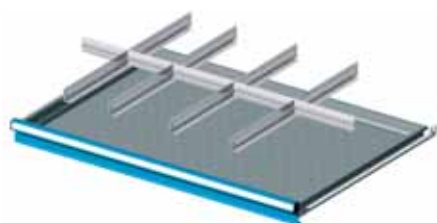

| ORD. NO. | FOR FRONT HEIGHTS |
|----------|-------------------|
|----------|-------------------|

| | |
|------------------------|---------|
| F FH 5005 07 00 | 50 |
| F FH 5007 07 00 | 75 |
| F FH 5010 07 00 | 100-125 |
| F FH 5015 07 00 | 150-175 |
| F FH 5020 07 00 | 200-250 |
| F FH 5030 07 00 | 300 |
| Set including: | |
| 4 Slotted partitions | 610 mm |
| 2 Plain partitions | 149 mm |
| 3 Plain partitions | 200 mm |

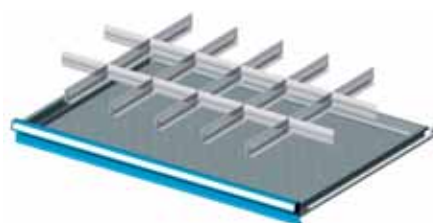

| ORD. NO. | FOR FRONT HEIGHTS |
|----------|-------------------|
|----------|-------------------|

| | |
|------------------------|---------|
| F FH 5005 13 00 | 50 |
| F FH 5007 13 00 | 75 |
| F FH 5010 13 00 | 100-125 |
| F FH 5015 13 00 | 150-175 |
| F FH 5020 13 00 | 200-250 |
| F FH 5030 13 00 | 300 |
| Set including: | |
| 5 Slotted partitions | 610 mm |
| 12 Plain partitions | 149 mm |



| ORD. NO. | FOR FRONT HEIGHTS |
|----------|-------------------|
|----------|-------------------|

| | |
|------------------------|---------|
| F FH 5005 14 00 | 50 |
| F FH 5007 14 00 | 75 |
| F FH 5010 14 00 | 100-125 |
| Set including: | |
| 6 Slotted partitions | 610 mm |
| 6 Plain partitions | 98 mm |
| 3 Plain partitions | 149 mm |
| 1 Plain partition | 200 mm |

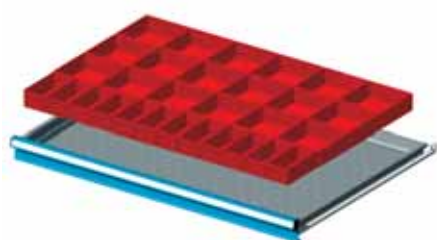

| ORD. NO. | FOR FRONT HEIGHTS |
|----------|-------------------|
|----------|-------------------|

| | |
|------------------------|------------|
| F FH 5005 08 00 | 50 |
| F FH 5007 08 00 | 75 |
| F FH 5010 08 00 | 100-125 |
| Set including: | |
| 12 Plastic boxes | 150x75 mm |
| 18 Plastic boxes | 150x150 mm |

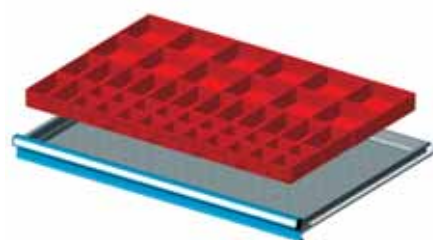

| ORD. NO. | FOR FRONT HEIGHTS |
|----------|-------------------|
|----------|-------------------|

| | |
|------------------------|------------|
| F FH 5005 17 00 | 50 |
| F FH 5007 17 00 | 75 |
| Set including: | |
| 20 Plastic boxes | 75x75 mm |
| 14 Plastic boxes | 150x75 mm |
| 12 Plastic boxes | 150x150 mm |

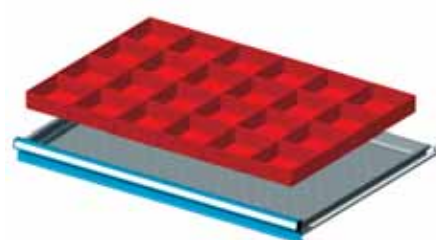

| ORD. NO. | FOR FRONT HEIGHTS |
|----------|-------------------|
|----------|-------------------|

| | |
|------------------------|------------|
| F FH 5005 18 00 | 50 |
| F FH 5007 18 00 | 75 |
| F FH 5010 18 00 | 100-125 |
| Set including: | |
| 24 Plastic boxes | 150x150 mm |

■ INFO



www.famispa.com

■ Partitioning material: see page A180



CABINETS SERIES STANDARD GC



ORD. NO. F AG 6034 S1 2Y
RAL 3020

64 EH (1076 mm)



36 EH (600 mm)

FLOOR FIXING SET

2x

- 2 "HILTI" plugs for concrete floors \geq to classes B25/RBK250/MPA 25 N/mm²
- Recommended traction of the plug: 2.9 KN
- Plug diameter: \varnothing 6 mm

ORD. NO. F AG 9204 00 99

CABINET FLOOR FIXING SET

- Pair of spare galvanised brackets
- \varnothing 6 mm hole



ORD. NO. F AG 9200 00 99

CABINET**ORD. NO.****F AG 6034 S1 2Y**

Complete with 5 drawers,
1 MDF top with rubber covering,
1 plinth for transpallet

Dimensions mm 1193x726x980 h

Tools and partitioning material excluded

RAL 7000 F..01

RAL 6011 F..02

RAL 5012 F..04

RAL 7035 F..08

SUPPLEMENTARY PARTS ■

- Partitioning material: see page **A129**



- **Spare key.** Always indicate the number on the cylinder lock of the key to be replaced.

ORD. NO. R CSC 0002 00

- **Master key.** This type of key opens all the 45 and 46 series locks.

ORD. NO. R CSC 0001 00



LENGTH = 1193 mm DEPTH = 726 mm (64x36 Eh)

CABINETS SERIES STANDARD GC

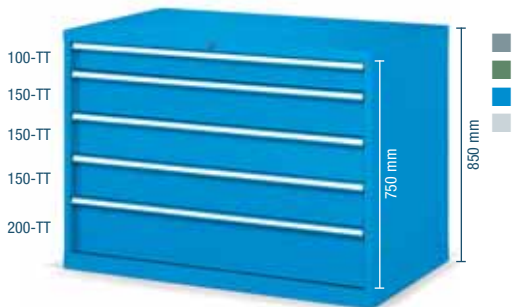

| ORD. NO. | DRAWERS |
|--|----------|
| F AG 6034 01 04 | 5 |
| Cabinet with 5 full telescopic extension drawers | |
| Dimensions mm 1193x726x850 h | |
| Central lock | |

| ORD. NO. | DRAWERS |
|--|----------|
| F AG 6034 02 04 | 6 |
| Cabinet with 6 full telescopic extension drawers | |
| Dimensions mm 1193x726x850 h | |
| Central lock | |



| ORD. NO. | DRAWERS |
|--|----------|
| F AG 6040 01 04 | 7 |
| Cabinet with 7 full telescopic extension drawers | |
| Dimensions mm 1193x726x1000 h | |
| Central lock | |

| ORD. NO. | DRAWERS |
|--|----------|
| F AG 6040 02 04 | 8 |
| Cabinet with 8 full telescopic extension drawers | |
| Dimensions mm 1193x726x1000 h | |
| Central lock | |



| ORD. NO. | DRAWERS |
|--|----------|
| F AG 6040 03 04 | 8 |
| Cabinet with 8 full telescopic extension drawers | |
| Dimensions mm 1193x726x1000 h | |
| Central lock | |

| ORD. NO. | DRAWERS |
|--|----------|
| F AG 6040 04 04 | 1 |
| Cabinet with 1 drawer, 2 retractable shelves | |
| Dimensions mm 1193x726x1000 h | |
| Without lock, with anti-tilt rod | |

KEY



- TT = telescopic full extension (100%)
- PE-TT = full telescopic retractable shelf (100%)
- The cabinets must be secured to the floor or to the wall

RAL 7000 F... ..01 RAL 6011 F... ..02 RAL 5012 F... ..04 RAL 7035 F... ..08

■ Partitioning material: see page A129

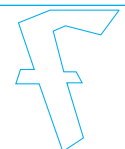

CABINETS SERIES STANDARD GC



| ORD. NO. | DRAWERS |
|--|----------|
| F AG 6053 01 04 | 9 |
| Cabinet with 9 full telescopic extension drawers | |
| Dimensions mm 1193x726x1325 h | |
| Central lock | |



| ORD. NO. | DRAWERS |
|---|-----------|
| F AG 6053 02 04 | 10 |
| Cabinet with 10 full telescopic extension drawers | |
| Dimensions mm 1193x726x1325 h | |
| Central lock | |



| ORD. NO. | DRAWERS |
|---|-----------|
| F AG 6058 01 04 | 10 |
| Cabinet with 10 full telescopic extension drawers | |
| Dimensions mm 1193x726x1450 h | |
| Central lock | |



| ORD. NO. | SHELVES |
|--|----------|
| F AG 6058 04 04 | 3 |
| Cabinet with 1 adjustable shelf, 2 retractable shelves | |
| Dimensions mm 1193x726x1450 h | |
| Without lock, with anti-tilt rod | |

RAL 7000 F... ..01 RAL 6011 F... ..02 RAL 5012 F... ..04 RAL 7035 F... ..08

KEY ■

- TT = telescopic full extension (100%)
- PE-TT = full telescopic retractable shelf (100%)
- PR = height adjustable shelf
- The cabinets must be secured to the floor or to the wall

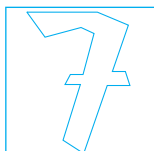

■ Partitioning material: see page A129

LENGTH = 1193 mm DEPTH = 726 mm (64x36 Eh)

CABINETS SERIES STANDARD GC



| ORD. NO. | DRAWERS |
|--|----------|
| F AG L634 02 04 | 4 |
| Cabinet with 4 full telescopic extension drawers | |
| Cabinet load capacity: 600 kg | |
| Ø 160 mm elastic rubber wheels | |
| Dimensions mm 1268x727x1121 h | |
| Central lock | |

| ORD. NO. | DRAWERS |
|--|----------|
| F AG L634 01 04 | 5 |
| Cabinet with 5 full telescopic extension drawers | |
| Cabinet load capacity: 600 kg | |
| Ø 160 mm elastic rubber wheels | |
| Dimensions mm 1268x727x1121 h | |
| Central lock | |



| ORD. NO. | DRAWERS |
|--|----------|
| F AG L640 01 04 | 6 |
| Cabinet with 6 full telescopic extension drawers | |
| Cabinet load capacity: 600 kg | |
| Ø 160 mm elastic rubber wheels | |
| Dimensions mm 1268x727x1271 h | |
| Central lock | |

| ORD. NO. | DRAWERS |
|--|----------|
| F AG L640 02 04 | 7 |
| Cabinet with 7 full telescopic extension drawers | |
| Cabinet load capacity: 600 kg | |
| Ø 160 mm elastic rubber wheels | |
| Dimensions mm 1268x727x1271 h | |
| Central lock | |

KEY

RAL 7000 F... ..01 RAL 6011 F... ..02 RAL 5012 F... ..04 RAL 7035 F... ..08



- TT = telescopic full extension (100%)
- All indicated loads are net and refer to evenly distributed weights



■ The handles can be fitted towards the bottom thereby reducing the height by 38 mm.

■ Partitioning material: see page A129



CABINETS SERIES STANDARD GC

EMPTY CABINETS

| ORD. NO. | USABLE HEIGHT mm | LOAD CAPACITY kg | DIMENSIONS mm |
|-----------------|------------------|------------------|-----------------|
| F AG 6034 00 04 | 750 | 3100 | 1193x726x850 h |
| F AG 6040 00 04 | 900 | 3100 | 1193x726x1000 h |
| F AG 6053 00 04 | 1225 | 3100 | 1193x726x1325 h |
| F AG 6058 00 04 | 1350 | 3100 | 1193x726x1450 h |

■ The cabinets must be secured to the floor or to the wall. If the cabinets are stacked they must be secured to the wall and their load capacity must be divided by 2. Further information for fixing set see page A122.



SPARE LOCK
ORD. NO.
R CSR 0003 00
for cabinet

■ 01 ■ 02 ■ 04 ■ 08

FULL TELESCOPIC EXTENSION DRAWERS (TT)

| ORD. NO. | FRONT HEIGHT mm | LOAD CAPACITY kg | USABLE DIMENSIONS mm |
|-----------------|-----------------|------------------|----------------------|
| F FG 6107 00 04 | 75 | 150 | 1076x600x54 h |
| F FG 6110 00 04 | 100 | 150 | 1076x600x79 h |
| F FG 6112 00 04 | 125 | 150 | 1076x600x104 h |
| F FG 6115 00 04 | 150 | 150 | 1076x600x129 h |
| F FG 6120 00 04 | 200 | 150 | 1076x600x179 h |
| F FG 6125 00 04 | 250 | 150 | 1076x600x229 h |
| F FG 6130 00 04 | 300 | 150 | 1076x600x279 h |

Full telescopic extension (100%)



■ 01
■ 02
■ 04
■ 08

■ Partitioning material: see page A129

FULL TELESCOPIC EXTENSION SHELVES (PE-TT)

| ORD. NO. | SIDE HEIGHT mm | LOAD CAPACITY kg | USABLE DIMENSIONS mm |
|-----------------|----------------|------------------|----------------------|
| F FG 8160 00 04 | — | 150 | 1086x610 |

Full telescopic extension (100%)



■ 01
■ 02
■ 04
■ 08

ADJUSTABLE SHELVES

| ORD. NO. | SIDE HEIGHT mm | LOAD CAPACITY kg | USABLE DIMENSIONS mm |
|-----------------|----------------|------------------|----------------------|
| F SR 1280 01 04 | 35 | 150 | 1137x618 |

Without extension system



■ 01
■ 02
■ 04
■ 08

CABINET TO CABINET FIXING

■ The article includes:
4 M8 nuts and bolts

ORD. NO. F AG 9202 00 99

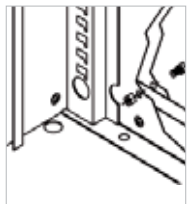

TWO SIDED ADHESIVE TAPE

ORD. NO.

R CMV 0025 00

width 15 mm, length 50 metres



■ 07

TOP SHELF

ORD. NO.

DIMENSIONS mm

F AG 9015 01 07

1193x726x20 h

oil-resistant rubber cover top with 3 edges



■ 07

PLINTHS

ORD. NO.

F RR 0100 00 07

Plinths height 50 mm



■ 07

PLINTHS FOR TRANSPALLET

ORD. NO.

F RR 0235 00 07 Plinths height 100 mm

F RR 0435 00 07 Facing piece



■ 07

PLINTHS FOR FORK LIFT TRUCK

ORD. NO.

F RR 0230 00 07 Pair of plinths height 60 mm

F RR 0430 00 07 Facing piece

LENGTH = 1193 mm DEPTH = 726 mm (64x36 Eh)

CABINETS SERIES STANDARD GC

UPPER MDF TOP WITH RUBBER COVERING DIMENSIONS 1194x726x31,5 mm H

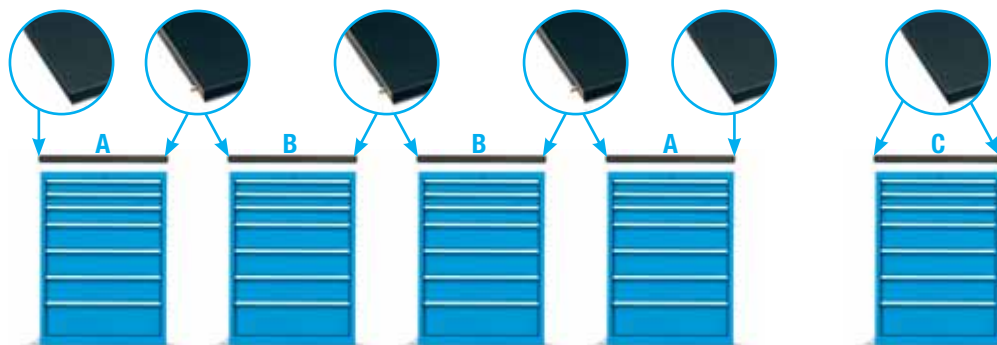

ORD. NO. F UZ 9998 00 00

Drilling of the cabinet upper shelf for the MDF top fixing.



Detail of the oil-resistant rubber

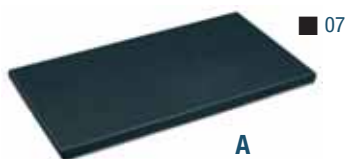

A



B

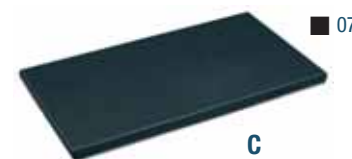

C

ORD. NO.

F UZ 3250 11 07

MDF top with rubber covering

Side profile

For end cabinets

Oil-resistant rubber mat

ORD. NO.

F UZ 3250 12 07

MDF top with rubber covering

No side profile

For additional central cabinets Oil-resist. rubber mat

ORD. NO.

F UZ 3250 13 07

MDF top with rubber covering

2 side profiles

For single cabinet

Oil-resistant rubber mat

CABINETS PREPARED FOR WHEELS

Cabinets prepared for wheels including: wheel plate, 4 edged top with oil-resistant rubber, 2 steel handles covered with shock-resistant rubber, cylinder lock with 2 keys, anti-tilt rod.

- 01
- 02
- 04
- 08



- 01
- 02
- 04
- 08



ORD. NO.

F AG 0634 00 04

Overall dim. mm:

1268x727x917 h without wheels

*Wheel plate thickness

ORD. NO.

F AG 0640 00 04

Overall dim. mm:

1268x727x1067 h without wheels

*Wheel plate thickness



■ The single drawer opening system ORD. NO. F DD 9400 00 07 must be applied to all drawers of mobile cabinets.

Other types of wheels see page A52

ELASTIC RUBBER SWIVEL WHEEL WITH BRAKE

| ORD. NO. | Ø mm | CABINET LOAD CAPACITY | C mm |
|----------------|------|-----------------------|------|
| C RG DCE15 160 | 160 | 600 kg | 204 |

NYLON SWIVEL WHEEL WITH BRAKE

| ORD. NO. | Ø mm | CABINET LOAD CAPACITY | C mm |
|----------------|------|-----------------------|------|
| C RN DAD04 160 | 160 | 600 kg | 204 |

ELASTIC RUBBER FIXED WHEEL

| ORD. NO. | Ø mm | CABINET LOAD CAPACITY | C mm |
|----------------|------|-----------------------|------|
| C RG BCE15 160 | 160 | 600 kg | 204 |

NYLON FIXED WHEEL

| ORD. NO. | Ø mm | CABINET LOAD CAPACITY | C mm |
|----------------|------|-----------------------|------|
| C RN BAD04 160 | 160 | 600 kg | 204 |

KEY

- RAL 7000 F... ..01
- RAL 6011 F... ..02
- RAL 5012 F... ..04
- RAL 7035 F... ..08



■ All indicated loads are net and refer to evenly distributed weights



■ The handles can be fitted towards the bottom thereby reducing the height by 38 mm.



CABINETS SERIES STANDARD GC

ORD. NO. F BL 1020 00 00
Steel vice 130 mm

**CABINET WITH WHEELS****ORD. NO.****F AG L634 S1 2Y**

complete with 5 drawers

1 multiplex worktop 40 mm thickness

Dimensions mm 1268x750x1101 h

Tools and partitioning material excluded

■ RAL 3020

RAL 7000 F... ..01

RAL 6011 F... ..02

RAL 5012 F... ..04

RAL 7035 F... ..08

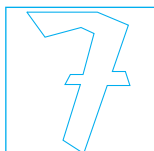
INFO ■

■ Partitioning material: see page **A180**

www.famispa.com



LENGTH = 1193 mm DEPTH = 726 mm (64x36 Eh)

CABINETS SERIES STANDARD GC

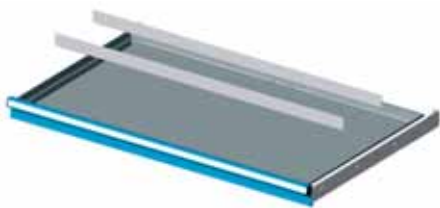

| ORD. NO. | FOR FRONT HEIGHTS |
|----------|-------------------|
|----------|-------------------|

| | |
|------------------------|---------|
| F FH 6007 10 00 | 75 |
| F FH 6010 10 00 | 100-125 |
| F FH 6015 10 00 | 150-175 |
| F FH 6020 10 00 | 200-250 |
| F FH 6030 10 00 | 300 |

Set including:
2 Plain partitions 1085 mm



| ORD. NO. | FOR FRONT HEIGHTS |
|----------|-------------------|
|----------|-------------------|

| | |
|------------------------|---------|
| F FH 6007 09 00 | 75 |
| F FH 6010 09 00 | 100-125 |
| F FH 6015 09 00 | 150-175 |
| F FH 6020 09 00 | 200-250 |
| F FH 6030 09 00 | 300 |

Set including:
4 Plain partitions 1085 mm

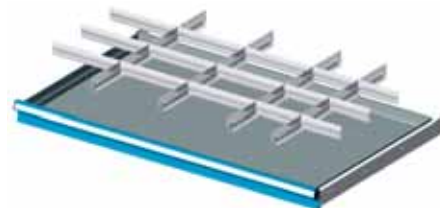

| ORD. NO. | FOR FRONT HEIGHTS |
|----------|-------------------|
|----------|-------------------|

| | |
|------------------------|---------|
| F FH 6007 02 00 | 75 |
| F FH 6010 02 00 | 100-125 |
| F FH 6015 02 00 | 150-175 |
| F FH 6020 02 00 | 200-250 |

Set including:
4 Slotted partitions 610 mm
3 Plain partitions 149 mm
3 Plain partitions 166 mm
9 Plain partitions 251 mm

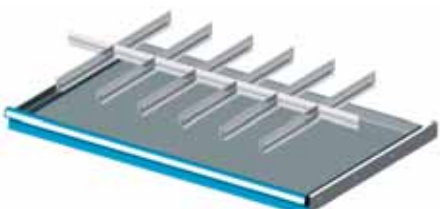

| ORD. NO. | FOR FRONT HEIGHTS |
|----------|-------------------|
|----------|-------------------|

| | |
|------------------------|---------|
| F FH 6007 11 00 | 75 |
| F FH 6010 11 00 | 100-125 |
| F FH 6015 11 00 | 150-175 |
| F FH 6020 11 00 | 200-250 |
| F FH 6030 11 00 | 300 |

Set including:
6 Slotted partitions 610 mm
6 Plain partitions 149 mm
1 Plain partition 166 mm

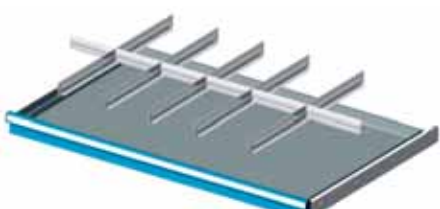

| ORD. NO. | FOR FRONT HEIGHTS |
|----------|-------------------|
|----------|-------------------|

| | |
|------------------------|---------|
| F FH 6007 08 00 | 75 |
| F FH 6010 08 00 | 100-125 |
| F FH 6015 08 00 | 150-175 |
| F FH 6020 08 00 | 200-250 |
| F FH 6030 08 00 | 300 |

Set including:
5 Slotted partitions 610 mm
2 Plain partitions 149 mm
1 Plain partition 166 mm
3 Plain partitions 200 mm

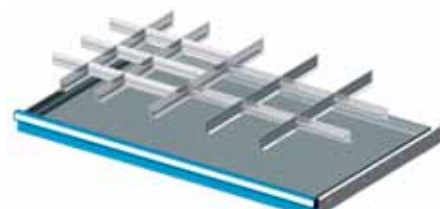

| ORD. NO. | FOR FRONT HEIGHTS |
|----------|-------------------|
|----------|-------------------|

| | |
|------------------------|---------|
| F FH 6007 05 00 | 75 |
| F FH 6010 05 00 | 100-125 |
| F FH 6015 05 00 | 150-175 |

Set including:
5 Slotted partitions 610 mm
6 Plain partitions 132 mm
9 Plain partitions 200 mm

■ INFO



■ Partitioning material: see page A180



www.famispa.com



ORD. NO. F BL 1020 00 00

Steel vice 130 mm



ORD. NO. F AG 7034 S1 56

RAL 7035+7000

78 EH (1314 mm)

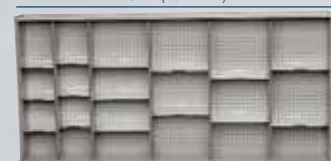

36 EH (600 mm)

FLOOR FIXING SET

2x

- 2 "HILTI" plugs for concrete floors \geq to classes B25/RBK250/MPa 25 N/mm²
- Recommended traction of the plug: 2.9 KN
- Plug diameter: \varnothing 6 mm

ORD. NO. F AG 9204 00 99

CABINET FLOOR FIXING SET

- Pair of spare galvanised brackets
- \varnothing 6 mm hole



ORD. NO. F AG 9200 00 99

CABINET**ORD. NO.****F AG 7034 S1 56**

Complete with 7 drawers

1 multiplex worktop 40 mm thickness

1 plinth for transpallet

Dimensions mm 1500x750x990 h

Tools and partitioning material excluded

RAL 7000 F.01

RAL 6011 F.02

RAL 5012 F.04

RAL 7035 F.08

SUPPLEMENTARY PARTS ■

- Partitioning material: see page A137



- **Spare key.** Always indicate the number on the cylinder lock of the key to be replaced.

ORD. NO. R CSC 0002 00

- **Master key.** This type of key opens all the 45 and 46 series locks.

ORD. NO. R CSC 0001 00



LENGTH = 1431 mm DEPTH = 726 mm (78x36 Eh)

CABINETS SERIES STANDARD GD

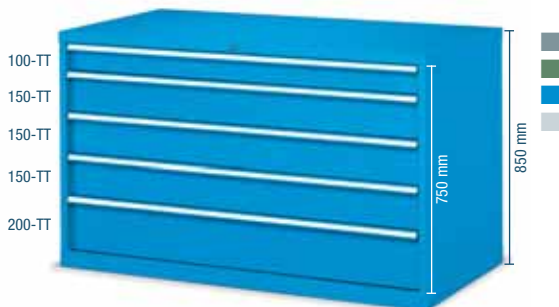

| ORD. NO. | DRAWERS |
|--|----------|
| F AG 7034 01 04 | 5 |
| Cabinet with 5 full telescopic extension drawers | |
| Dimensions mm 1431x726x850 h | |
| Central lock | |

| ORD. NO. | DRAWERS |
|--|----------|
| F AG 7034 02 04 | 6 |
| Cabinet with 6 full telescopic extension drawers | |
| Dimensions mm 1431x726x850 h | |
| Central lock | |



| ORD. NO. | DRAWERS |
|--|----------|
| F AG 7040 01 04 | 7 |
| Cabinet with 7 full telescopic extension drawers | |
| Dimensions mm 1431x726x1000 h | |
| Central lock | |

| ORD. NO. | DRAWERS |
|--|----------|
| F AG 7040 02 04 | 8 |
| Cabinet with 8 full telescopic extension drawers | |
| Dimensions mm 1431x726x1000 h | |
| Central lock | |



| ORD. NO. | DRAWERS |
|--|----------|
| F AG 7040 03 04 | 8 |
| Cabinet with 8 full telescopic extension drawers | |
| Dimensions mm 1431x726x1000 h | |
| Central lock | |

| ORD. NO. | SHELVES |
|--------------------------------------|----------|
| F AG 7040 05 04 | 2 |
| Cabinet with 2 retractable shelves | |
| Dimensions mm 1431x726x1000 h | |
| Without lock, with anti-tilt rod | |

KEY



- TT = telescopic full extension (100%)
- PE-TT = full telescopic retractable shelf (100%)
- The cabinets must be secured to the floor or to the wall

RAL 7000 F... ..01 RAL 6011 F... ..02 RAL 5012 F... ..04 RAL 7035 F... ..08

■ Partitioning material: see page A137



CABINETS SERIES STANDARD GD



| •ORD. NO. | DRAWERS |
|--|----------|
| F AG 7053 01 04 | 9 |
| Cabinet with 9 full telescopic extension drawers | |
| Dimensions mm 1431x726x1325 h | |
| Central lock | |



| •ORD. NO. | DRAWERS |
|---|-----------|
| F AG 7053 02 04 | 10 |
| Cabinet with 10 full telescopic extension drawers | |
| Dimensions mm 1431x726x1325 h | |
| Central lock | |



| •ORD. NO. | DRAWERS |
|---|-----------|
| F AG 7058 01 04 | 10 |
| Cabinet with 10 full telescopic extension drawers | |
| Dimensions mm 1431x726x1450 h | |
| Central lock | |



| ORD. NO. | SHELVES |
|--|----------|
| F AG 7058 04 04 | 3 |
| Cabinet with 1 adjustable shelf, 2 retractable shelves | |
| Dimensions mm 1431x726x1450 h | |
| Without lock, with anti-tilt rod | |

RAL 7000 F.01 RAL 6011 F.02 RAL 5012 F.04 RAL 7035 F.08

KEY ■

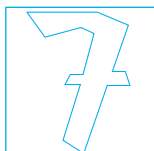

■ Partitioning material: see page A137

- TT = telescopic full extension (100%)
- PE-TT = full telescopic retractable shelf (100%)
- PR = height adjustable shelf
- The cabinets must be secured to the floor or to the wall



LENGTH = 1431 mm DEPTH = 726 mm (78x36 Eh)

CABINETS SERIES STANDARD GD



ORD. NO.

DRAWERS

F AG L734 02 04**4**

Cabinet with 4 full telescopic extension drawers

Cabinet load capacity: 600 kg

Ø 160 mm elastic rubber wheels

Dimensions mm 1506x727x1121 h

Central lock



ORD. NO.

DRAWERS

F AG L734 01 04**5**

Cabinet with 5 full telescopic extension drawers

Cabinet load capacity: 600 kg

Ø 160 mm elastic rubber wheels

Dimensions mm 1506x727x1121 h

Central lock



ORD. NO.

DRAWERS

F AG L740 01 04**6**

Cabinet with 6 full telescopic extension drawers

Cabinet load capacity: 600 kg

Ø 160 mm elastic rubber wheels

Dimensions mm 1506x727x1271 h

Central lock



ORD. NO.

DRAWERS

F AG L740 02 04**7**

Cabinet with 7 full telescopic extension drawers

Cabinet load capacity: 600 kg

Ø 160 mm elastic rubber wheels

Dimensions mm 1506x727x1271 h

Central lock

KEY

RAL 7000 F... ..01 RAL 6011 F... ..02 RAL 5012 F... ..04 RAL 7035 F... ..08



- TT = telescopic full extension (100%)
- All indicated loads are net and refer to evenly distributed weights



■ The handles can be fitted towards the bottom thereby reducing the height by 38 mm.

■ Partitioning material: see page **A137**



CABINETS SERIES STANDARD GD

EMPTY CABINETS

| ORD. NO. | USABLE HEIGHT mm | LOAD CAPACITY kg | DIMENSIONS mm |
|-----------------|------------------|------------------|-----------------|
| F AG 7034 00 04 | 750 | 3100 | 1431x726x850 h |
| F AG 7040 00 04 | 900 | 3100 | 1431x726x1000 h |
| F AG 7053 00 04 | 1225 | 3100 | 1431x726x1325 h |
| F AG 7058 00 04 | 1350 | 3100 | 1431x726x1450 h |



SPARE LOCK

ORD. NO.
R CSR 0003 00
for cabinet

■ The cabinets must be secured to the floor or to the wall. If the cabinets are stacked they must be secured to the wall and their load capacity must be divided by 2. Further information for fixing set see page A130.

■ 01 ■ 02 ■ 04 ■ 08

FULL TELESCOPIC EXTENSION DRAWERS (TT)

| ORD. NO. | FRONT HEIGHT mm | LOAD CAPACITY kg | USABLE DIMENSIONS mm |
|-----------------|-----------------|------------------|----------------------|
| F FG 7107 00 04 | 75 | 150 | 1314x600x54 h |
| F FG 7110 00 04 | 100 | 150 | 1314x600x79 h |
| F FG 7112 00 04 | 125 | 150 | 1314x600x104 h |
| F FG 7115 00 04 | 150 | 150 | 1314x600x129 h |
| F FG 7117 00 04 | 175 | 150 | 1314x600x154 h |
| F FG 7120 00 04 | 200 | 150 | 1314x600x179 h |
| F FG 7125 00 04 | 250 | 150 | 1314x600x229 h |
| F FG 7130 00 04 | 300 | 150 | 1314x600x279 h |

Full telescopic extension (100%)

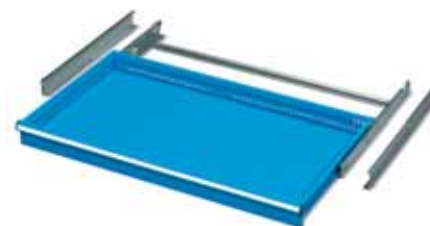

■ 01
■ 02
■ 04
■ 08

■ Partitioning material: see page A137

FULL TELESCOPIC EXTENSION SHELVES (PE-TT)

| ORD. NO. | SIDE HEIGHT mm | LOAD CAPACITY kg | USABLE DIMENSIONS mm |
|-----------------|----------------|------------------|----------------------|
| F FG 8170 00 04 | – | 150 | 1324x610 |

Full telescopic extension (100%)

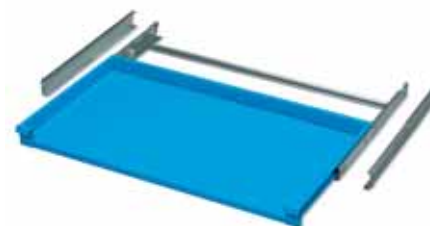

■ 01
■ 02
■ 04
■ 08

ADJUSTABLE SHELVES

| ORD. NO. | SIDE HEIGHT mm | LOAD CAPACITY kg | USABLE DIMENSIONS mm |
|-----------------|----------------|------------------|----------------------|
| F SR 1290 01 04 | 35 | 150 | 1375x618 |

Without extension system



■ 01
■ 02
■ 04
■ 08



TWO SIDED ADHESIVE TAPE

ORD. NO.

R CMV 0025 00

width 15 mm, length 50 metres



■ 07

TOP SHELF

ORD. NO.

DIMENSIONS mm

F AG 9018 01 07

1434x726x20 h

oil-resistant rubber cover top with 3 edges

CABINET TO CABINET FIXING

■ The article includes:
4 M8 nuts and bolts

ORD. NO. F AG 9202 00 99

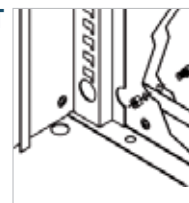

■ 07

PLINTHS

ORD. NO.

F RR 0115 00 07

Plinths height 50 mm



■ 07

PLINTHS FOR TRANSPALLET

ORD. NO.

F RR 0235 00 07 Plinths height 100 mm

F RR 0445 00 07 Facing piece



■ 07

PLINTHS FOR FORK LIFT TRUCK

ORD. NO.

F RR 0230 00 07 Pair of plinths height 60 mm

F RR 0440 00 07 Facing piece

LENGTH = 1431 mm DEPTH = 726 mm (78x36 Eh)

CABINETS SERIES STANDARD GD

UPPER MDF TOP WITH RUBBER COVERING DIMENSIONS 1434x726x31,5 mm H

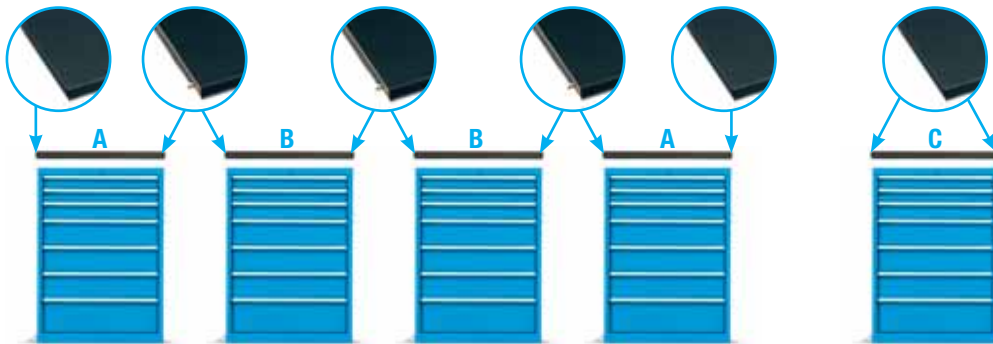

ORD. NO. F UZ 9998 00 00

Drilling of the cabinet upper shelf for the MDF top fixing.



Detail of the oil-resistant rubber

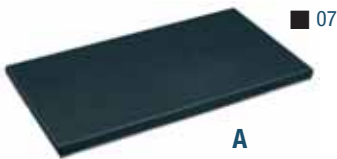

A



B

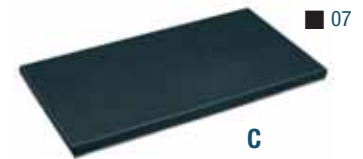

C

ORD. NO.

F UZ 3260 11 07

MDF top with rubber covering

Side profile

For end cabinets

Oil-resistant rubber mat

ORD. NO.

F UZ 3260 12 07

MDF top with rubber covering

No side profile

For additional central cabinets Oil-resist. rubber mat

ORD. NO.

F UZ 3260 13 07

MDF top with rubber covering

2 side profiles

For single cabinet

Oil-resistant rubber mat

CABINETS PREPARED FOR WHEELS

Cabinets prepared for wheels including: wheel plate, 4 edged top with oil-resistant rubber, 2 steel handles covered with shock-resistant rubber, cylinder lock with 2 keys, anti-tilt rod.

- 01
- 02
- 04
- 08



- 01
- 02
- 04
- 08



The single drawer opening system ORD. NO. F DD 9400 00 07 must be applied to all drawers of mobile cabinets.

ORD. NO.

F AG 0734 00 04

Overall dim. mm:
1506x727x917 h without wheels

*Wheel plate thickness

ORD. NO.

F AG 0740 00 04

Overall dim. mm:
1506x727x1067 h without wheels

*Wheel plate thickness

Other types of wheels see page A52



ELASTIC RUBBER SWIVEL WHEEL WITH BRAKE

ORD. NO. C RG DCE15 160 Ø mm 160 CABINET LOAD CAPACITY 600 kg C mm 204



ELASTIC RUBBER FIXED WHEEL

ORD. NO. C RG BCE15 160 Ø mm 160 CABINET LOAD CAPACITY 600 kg C mm 204



NYLON SWIVEL WHEEL WITH BRAKE

ORD. NO. C RN DAD04 160 Ø mm 160 CABINET LOAD CAPACITY 600 kg C mm 204



NYLON FIXED WHEEL

ORD. NO. C RN BAD04 160 Ø mm 160 CABINET LOAD CAPACITY 600 kg C mm 204

KEY

- RAL 7000 F.01
- RAL 6011 F.02
- RAL 5012 F.04
- RAL 7035 F.08



All indicated loads are net and refer to evenly distributed weights



The handles can be fitted towards the bottom thereby reducing the height by 38 mm.

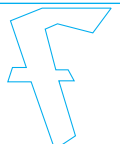

CABINETS SERIES STANDARD GD

**EXAMPLE INCLUDING:****ORD. NO.****F AG ZA03 00 56**

3 cabinets with drawers

Dimensions mm 1431x726x1850 h

Tools and partitioning material excluded

■ RAL 7035 + ■ RAL 7000

RAL 7000 F.01 RAL 6011 F.02 RAL 5012 F.04 RAL 7035 F.08

INFO ■■ Partitioning material: see page **A180**www.famispa.com

LENGTH = 1431 mm DEPTH = 726 mm (78x36 Eh)

CABINETS SERIES STANDARD GD

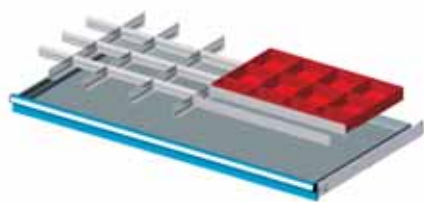

| ORD. NO. | FOR FRONT HEIGHTS |
|----------|-------------------|
|----------|-------------------|

| | |
|------------------------|---------|
| F FH 7007 01 00 | 75 |
| F FH 7010 01 00 | 100-125 |

Set including:

| | |
|----------------------|------------|
| 4 Slotted partitions | 610 mm |
| 2 Plain partitions | 610 mm |
| 6 Plain partitions | 149 mm |
| 6 Plain partitions | 200 mm |
| 4 Plastic boxes | 150x75 mm |
| 8 Plastic boxes | 150x150 mm |

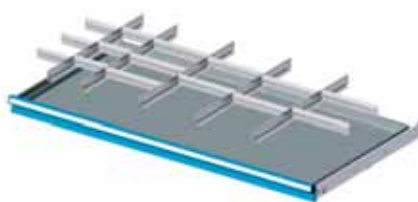

| ORD. NO. | FOR FRONT HEIGHTS |
|----------|-------------------|
|----------|-------------------|

| | |
|------------------------|---------|
| F FH 7007 02 00 | 75 |
| F FH 7010 02 00 | 100-125 |
| F FH 7015 02 00 | 150-175 |
| F FH 7020 02 00 | 200-250 |

Set including:

| | |
|----------------------|--------|
| 5 Slotted partitions | 610 mm |
| 6 Plain partitions | 149 mm |
| 9 Plain partitions | 251 mm |

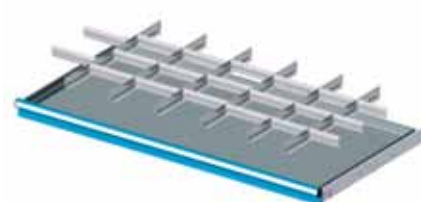

| ORD. NO. | FOR FRONT HEIGHTS |
|----------|-------------------|
|----------|-------------------|

| | |
|------------------------|---------|
| F FH 7007 03 00 | 75 |
| F FH 7010 03 00 | 100-125 |
| F FH 7015 03 00 | 150-175 |

Set including:

| | |
|----------------------|--------|
| 6 Slotted partitions | 610 mm |
| 3 Plain partitions | 132 mm |
| 3 Plain partitions | 166 mm |
| 14 Plain partitions | 200 mm |

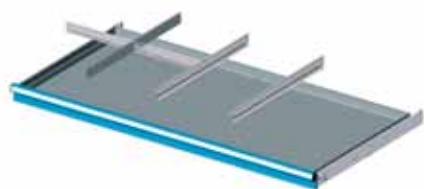

| ORD. NO. | FOR FRONT HEIGHTS |
|----------|-------------------|
|----------|-------------------|

| | |
|------------------------|---------|
| F FH 7007 04 00 | 75 |
| F FH 7010 04 00 | 100-125 |
| F FH 7015 04 00 | 150-175 |
| F FH 7020 04 00 | 200-250 |
| F FH 7030 04 00 | 300 |

Set including:

| | |
|----------------------|--------|
| 3 Slotted partitions | 610 mm |
| 2 Plain partitions | 302 mm |

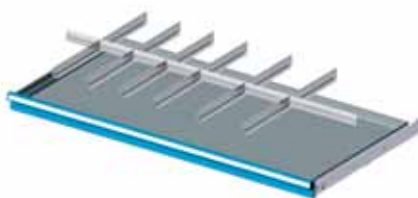

| ORD. NO. | FOR FRONT HEIGHTS |
|----------|-------------------|
|----------|-------------------|

| | |
|------------------------|---------|
| F FH 7007 07 00 | 75 |
| F FH 7010 07 00 | 100-125 |
| F FH 7015 07 00 | 150-175 |
| F FH 7020 07 00 | 200-250 |
| F FH 7030 07 00 | 300 |

Set including:

| | |
|----------------------|--------|
| 6 Slotted partitions | 610 mm |
| 4 Plain partitions | 149 mm |
| 2 Plain partitions | 200 mm |
| 1 Plain partition | 302 mm |

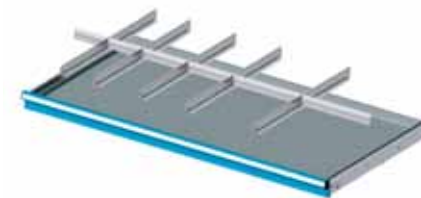

| ORD. NO. | FOR FRONT HEIGHTS |
|----------|-------------------|
|----------|-------------------|

| | |
|------------------------|---------|
| F FH 7007 08 00 | 75 |
| F FH 7010 08 00 | 100-125 |
| F FH 7015 08 00 | 150-175 |
| F FH 7020 08 00 | 200-250 |
| F FH 7030 08 00 | 300 |

Set including:

| | |
|----------------------|--------|
| 5 Slotted partitions | 610 mm |
| 2 Plain partitions | 149 mm |
| 2 Plain partitions | 200 mm |
| 2 Plain partitions | 302 mm |



■ INFO

■ Partitioning material: see page A180



www.famispa.com



CABINETS SERIES STANDARD FG-FI



ORD. NO. F AF 2040 S1 56
RAL 7035+7000

CABINET**ORD. NO.****F AF 2040 S1 56**

Complete with 1 pair of sliding doors

1 height adjustable shelf

1 MDF top with rubber covering

Dimensions mm 1431x726x1030 h

Tools, boxes and toolboxes excluded

LOAD CAPACITY: 200 kg

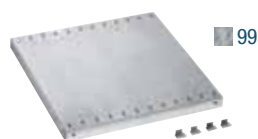

LOAD CAPACITY: 150 kg



RAL 7000 F... ..01 RAL 6011 F... ..02 RAL 5012 F... ..04 RAL 7035 F... ..08

SUPPLEMENTARY PARTS ■

■ All indicated loads are net and refer to evenly distributed weights



■ **Spare key.** Always indicate the number on the cylinder lock of the key to be replaced.

ORD. NO. R CSC 0002 00

■ **Master key.** This type of key opens all the 45 and 46 series locks.

ORD. NO. R CSC 0001 00



LENGTH = 1431 mm DEPTH = 726 mm

CABINETS SERIES STANDARD FG-FI



| ORD. NO. | SHELVES |
|-----------------------------------|----------|
| F AE 5040 13 04 | 1 |
| Cabinet with 1 shelf depth 623 mm | |
| Dimensions mm 1431x726x1000 h | |



| ORD. NO. | SHELVES |
|---|----------|
| F AE 5040 14 04 | 2 |
| Cabinet with 2 shelves depth 623 mm, 1 centre support | |
| Dimensions mm 1431x726x1000 h | |



| ORD. NO. | SHELVES |
|-----------------------------------|----------|
| F AF 2040 13 04 | 1 |
| Cabinet with 1 shelf depth 623 mm | |
| Dimensions mm 1431x726x1000 h | |



| ORD. NO. | SHELVES |
|---|----------|
| F AF 2040 14 04 | 2 |
| Cabinet with 2 shelves depth 623 mm, 1 centre support | |
| Dimensions mm 1431x726x1000 h | |



| ORD. NO. | SHELVES |
|-----------------------------------|----------|
| F AE 5053 13 04 | 1 |
| Cabinet with 1 shelf depth 623 mm | |
| Dimensions mm 1431x726x1325 h | |



| ORD. NO. | SHELVES |
|---|----------|
| F AE 5053 14 04 | 2 |
| Cabinet with 2 shelves depth 623 mm, 1 centre support | |
| Dimensions mm 1431x726x1325 h | |

■ INFO

RAL 7000 F... ..01 RAL 6011 F... ..02 RAL 5012 F... ..04 RAL 7035 F... ..08



www.famispa.com



CABINETS SERIES STANDARD FG-FI



ORD. NO.

SHELVES

F AF 2053 13 04**1**

Cabinet with 1 shelf depth 623 mm

Dimensions mm 1431x726x1325 h

ORD. NO.

SHELVES

F AF 2053 14 04**2**

Cabinet with 2 shelves depth 623 mm, 1 centre support

Dimensions mm 1431x726x1325 h



ORD. NO.

SHELVES

F AE 5058 13 04**1**

Cabinet with 1 shelf depth 623 mm

Dimensions mm 1431x726x1450 h

ORD. NO.

SHELVES

F AE 5058 14 04**2**

Cabinet with 2 shelves depth 623 mm, 1 centre support

Dimensions mm 1431x726x1450 h

RAL 7000 F.01

RAL 6011 F.02

RAL 5012 F.04

RAL 7035 F.08

INFO ■



LENGTH = 1431 mm DEPTH = 726 mm

CABINETS SERIES STANDARD FG-FI



| ORD. NO. | SHELVES |
|-----------------------------------|----------|
| F AF 2058 13 04 | 1 |
| Cabinet with 1 shelf depth 623 mm | |
| Dimensions mm 1431x726x1450 h | |

| ORD. NO. | SHELVES |
|---|----------|
| F AF 2058 14 04 | 2 |
| Cabinet with 2 shelves depth 623 mm, 1 centre support | |
| Dimensions mm 1431x726x1450 h | |

EXAMPLE INCLUDING:

| ORD. NO. |
|---|
| F AG ZA04 00 56 |
| 1 corner cabinet |
| 3 cabinets with drawers |
| 1 cabinet with sliding doors and adjustable shelf |
| 1 cabinet with adjustable shelf without sliding doors |
| 3 MDF tops with rubber covering |
| Tools, partitioning material and boxes excluded |

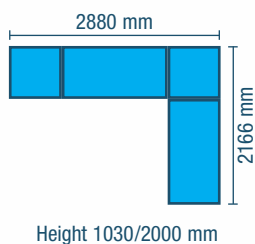

■ RAL 7035 +
■ RAL 7000

■ INFO

RAL 7000 F... ..01 RAL 6011 F... ..02 RAL 5012 F... ..04 RAL 7035 F... ..08



www.famispa.com



CABINETS SERIES STANDARD FG-FI

CABINET TO CABINET FIXING

■ The article includes:
4 M8 nuts and bolts

ORD. NO. F AG 9202 00 99

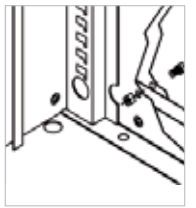

TWO SIDED ADHESIVE TAPE

ORD. NO.

R CMV 0025 00

width 15 mm, length 50 metres



■ 07

PLINTHS

ORD. NO.

F RR 0115 00 07

Plinths height 50 mm



■ 07

PLINTHS FOR TRANSPALLET

ORD. NO.

F RR 0235 00 07 Plinths height 100 mm

F RR 0445 00 07 Facing piece



■ 07

PLINTHS FOR FORK LIFT TRUCK

ORD. NO.

F RR 0230 00 07 Pair of plinths height 60 mm

F RR 0440 00 07 Facing piece

GALVANISED ADJUSTABLE SHELVES



■ 99

■ This type of shelf can only be used when there is a centre support.

ORD. NO.

F AF 9109 03 99

Load capacity: 200 kg

Dimensions mm 683x623x35 h



■ 99

ORD. NO.

F AF 9139 05 99

Load capacity: 150 kg

Dimensions mm 1395x623x35 h

adjustable shelf

ORD. NO. F AF 9109 03 99



centre support

adjustable shelf

ORD. NO. F AF 9139 05 99



CONTAINERS

■ see page G28-G30



size 4



size 4A2



size 4A5

RAL 7000 F... ..01

RAL 6011 F... ..02

RAL 5012 F... ..04

RAL 7035 F... ..08

KEY ■

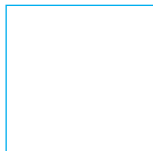
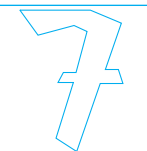

■ All indicated loads are net and refer to evenly distributed weights



LENGTH = 1431 mm DEPTH = 726 mm

CABINETS SERIES STANDARD FG-FI



■ 99

SHELF DIVIDERS

ORD. NO.

F AF 9400 00 99

shelf divider



■ 99

SIDE PANEL

ORD. NO.

F AF 9420 00 99

Shelves side panel



■ 07

TOP SHELF

ORD. NO.

DIMENSIONS mm

F AG 9018 01 07

1431x726x20 h

oil-resistant rubber cover top with 3 edges

SPARE LOCKS FOR CABINETS SERIES F AE

ORD. NO.

R CSR 0008 00

Spare locks for cabinets ORD. NO. F AE 5040 - 5053 - 5058

R XAE 0006 99

Spare rods for cabinets ORD. NO. F AE 5058

R XAE 0004 99

Spare rods for cabinets ORD. NO. F AE 5040

R XAE 0005 99

Spare rods for cabinets ORD. NO. F AE 5053

SPARE LOCKS FOR CABINETS SERIES F AF

ORD. NO.

R CSR 0012 00

Spare lock

■ Spare key see page A138

UPPER MDF TOP WITH RUBBER COVERING DIMENSIONS 1434x726x31,5 mm H

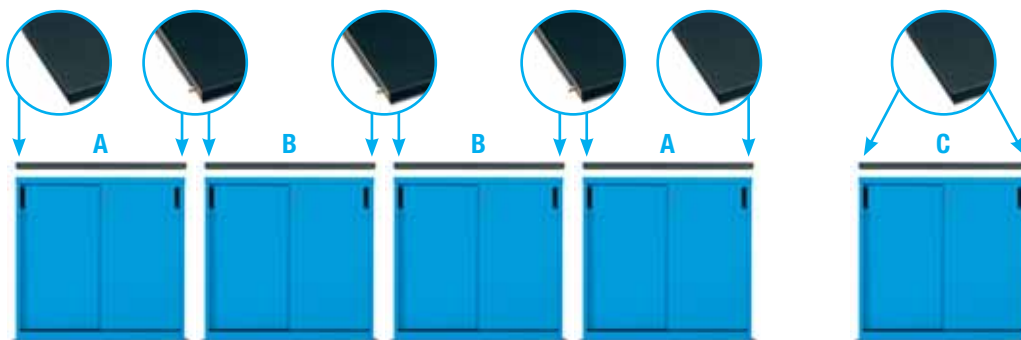

ORD. NO. F UZ 9998 00 00

Drilling of the cabinet upper shelf for the MDF top fixing.



Detail of the oil-resistant rubber

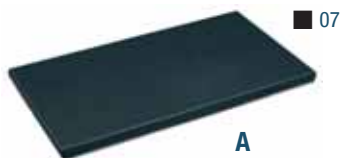

■ 07

A

ORD. NO.

F UZ 3260 11 07

MDF top with rubber covering

Side profile

For end cabinets

Oil-resistant rubber mat



■ 07

B

ORD. NO.

F UZ 3260 12 07

MDF top with rubber covering

No side profile

For additional central cabinets

Oil-resist. rubber mat

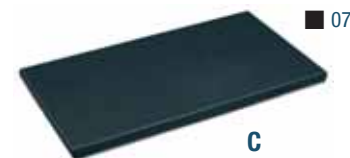

■ 07

C

ORD. NO.

F UZ 3260 13 07

MDF top with rubber covering

2 side profiles

For single cabinet

Oil-resistant rubber mat

■ INFO

RAL 7000 F... ..01 RAL 6011 F... ..02 RAL 5012 F... ..04 RAL 7035 F... ..08



www.famispaspa.com



CORNER CABINETS SERIES
STANDARD FL-G

DEPTH = 726 mm (36 Eh)

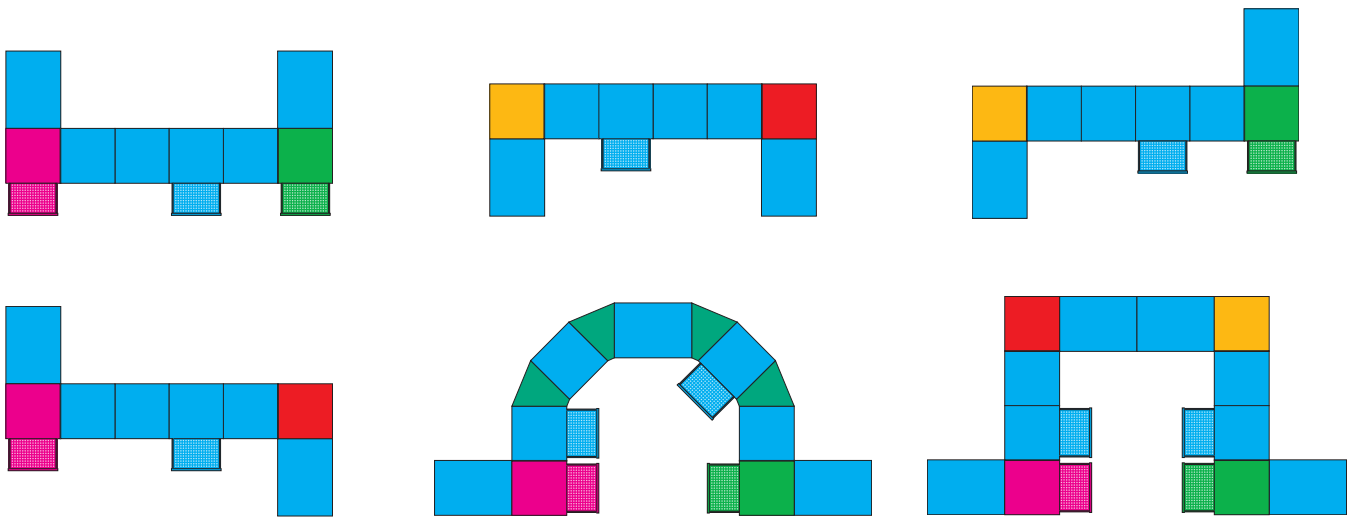

- RAL 7000 F.01
- RAL 6011 F.02
- RAL 5012 F.04
- RAL 7035 F.08

SUPPLEMENTARY PARTS ■

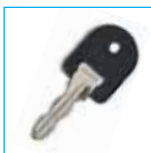
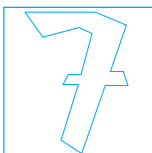

- **Spare key.** Always indicate the number on the cylinder lock of the key to be replaced.
ORD. NO. R CSC 0002 00
- **Master key.** This type of key opens all the 45 and 46 series locks.
ORD. NO. R CSC 0001 00



DEPTH = 726 mm (36 Eh)

CORNER CABINETS SERIES
STANDARD FL-G

WOODEN COVERS: PLEASE, CONTACT FAMI FOR DETAILED INFORMATION.



ORD. NO.

F AG 0050 00 04

45° angle

Dimensions mm 653x671x1000 h

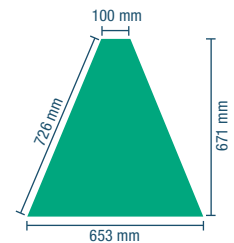
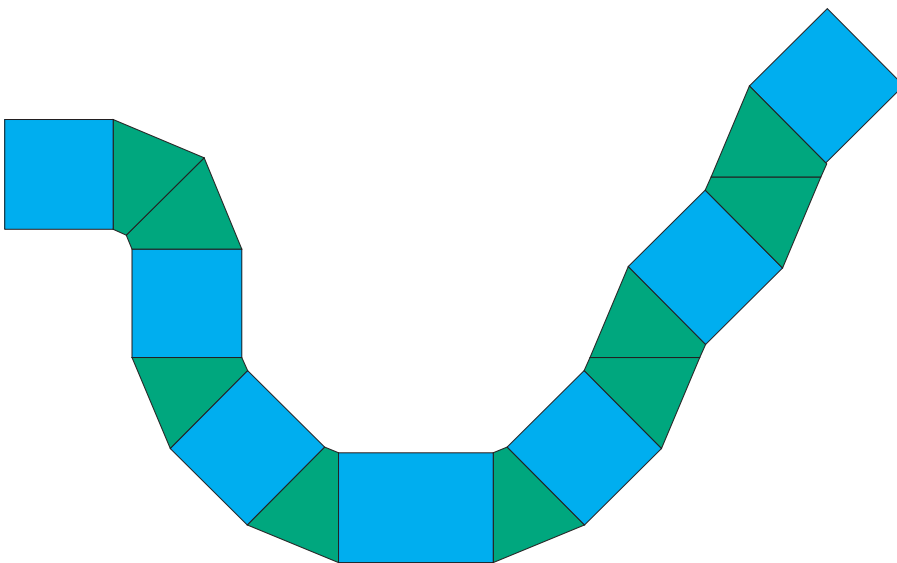

■ This corner cabinet can stick with 726 mm (36 Eh) depth STANDARD series cabinets only.

■ INFO

RAL 7000 F..01

RAL 6011 F..02

RAL 5012 F..04

RAL 7035 F..08



www.famispaspa.com

CORNER CABINETS SERIES STANDARD FL-G

DEPTH = 726 mm (36 Eh)

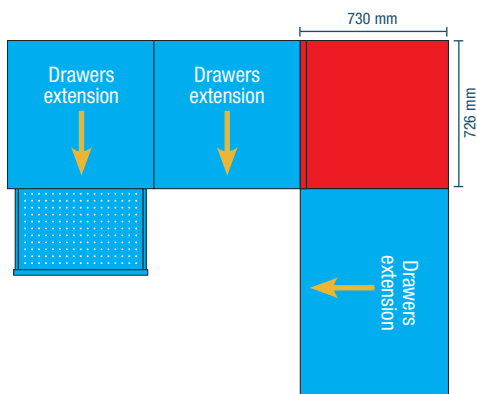

Back view



■ This corner cabinets can stick with 726 mm (36 Eh) depth STANDARD series cabinets only.



ORD. NO.

F AG 2040 R1 04
Right side external corner cabinet
Dimensions mm 730x726x1000 h



ORD. NO.

F AG 2040 R2 04
Right side external corner cabinet
with MDF top and oil-resistant rubber cover
Dimensions mm 730x726x1030 h



ORD. NO.

F AG 2040 L1 04
Left side external corner cabinet
Dimensions mm 730x726x1000 h



ORD. NO.

F AG 2040 L2 04
Left side external corner cabinet
with MDF top and oil-resistant rubber cover
Dimensions mm 730x726x1030 h

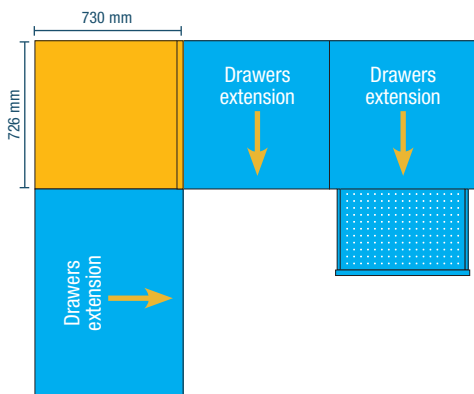

RAL 7000 F.01 RAL 6011 F.02 RAL 5012 F.04 RAL 7035 F.08

KEY ■

■ The cabinets must be secured to the floor or to the wall



DEPTH = 726 mm (36 Eh)

CORNER CABINETS SERIES STANDARD FL-G



Back view

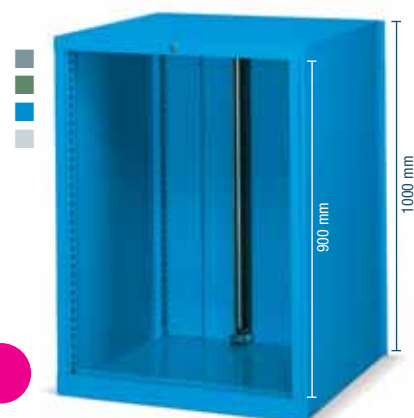

ORD. NO.

F AG 2040 L3 04

Left side internal corner cabinet
Dimensions mm 730x726x1000 h



ORD. NO.

F AG 2040 L4 04

Left side internal corner cabinet
with MDF top and oil-resistant rubber cover
Dimensions mm 730x726x1030 h

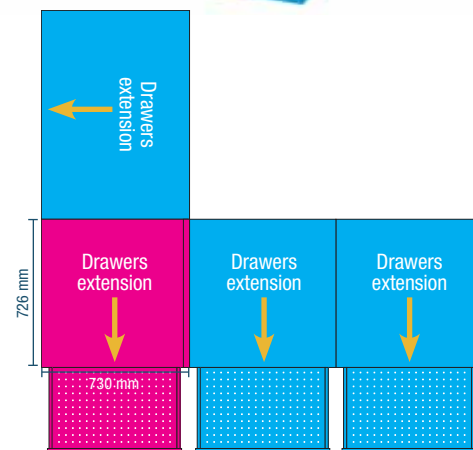

■ This corner cabinets can stick with 726 mm (36 Eh) depth STANDARD series cabinets only.



ORD. NO.

F AG 2040 R3 04

Right side internal corner cabinet
Dimensions mm 730x726x1000 h



ORD. NO.

F AG 2040 R4 04

Right side internal corner cabinet
with MDF top and oil-resistant rubber cover
Dimensions mm 730x726x1030 h

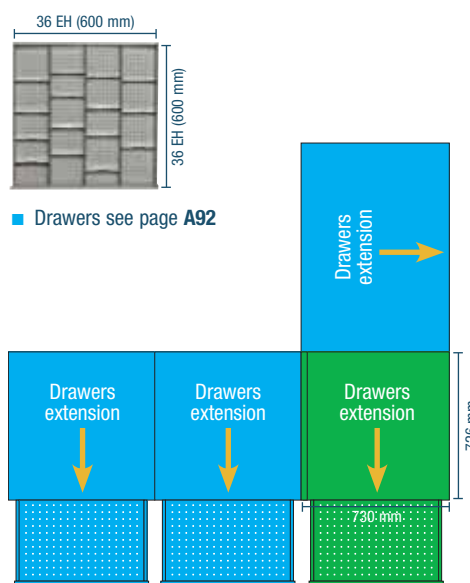

KEY

- RAL 7000 F... ..01
- RAL 6011 F... ..02
- RAL 5012 F... ..04
- RAL 7035 F... ..08



■ The cabinets must be secured to the floor or to the wall



CORNER CABINETS SERIES
STANDARD F DA

DEPTH = 554 mm (27 Eh)

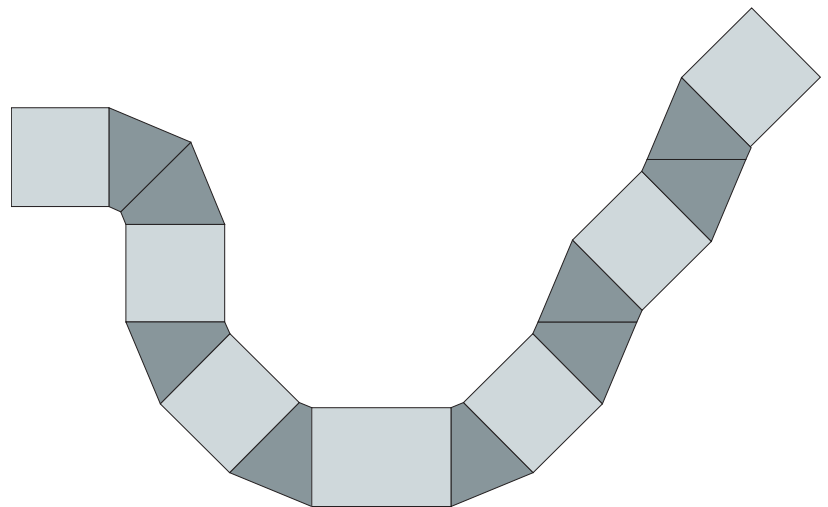
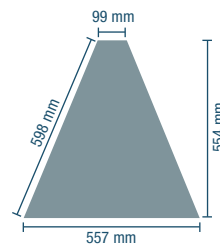
**ORD. NO.****F DA 0050 00 01**

45° angle

Dimensions mm 557x554x1000 h

■ This corner cabinet can stick with 600 mm (27 Eh) depth FLEXA series cabinets only or with cabinets of the PERFORM A800, A600 and A400 series.

RAL 7000 F.01

RAL 6011 F.02

RAL 5012 F.04

RAL 7035 F.08

INFO ■
www.famispa.com

DEPTH = 554 mm (27 Eh)

CORNER CABINETS SERIES
STANDARD F DA**ORD. NO.****F BS 9140 00 00**

Top cover with laminate with 2 rounded edges for
FLEXA F DL cabinets and PERFORM cabinets
series F AB 4100

Dimensions mm 1024x650x30 h

**ORD. NO.****F BS 9130 00 00**

Top cover with laminate with 2 rounded edges for
cabinets series F DG/F DF

Dimensions mm 718x650x30 h

**ORD. NO.****F BS 9110 00 00**

Top cover with laminate only for use with corner
cabinet ORD. NO. F DA 0050 00 ..

Dimensions mm 577x601x30 h



■ INFO



www.famispa.com



CABINETS SERIES STANDARD F27



ORD. NO. F AF 1040 15 08
RAL 7035

ORD. NO. F AE 1040 14 50
RAL 7035+5012

FLOOR FIXING SET



2x

- 2 "HILTI" plugs for concrete floors \geq to classes B25/RBK250/MPA 25 N/mm²
- Recommended traction of the plug: 2.9 KN
- Plug diameter: \varnothing 6 mm

ORD. NO. F AG 9204 00 99

CABINET FLOOR FIXING SET

- Pair of spare galvanised brackets
- \varnothing 6 mm hole



ORD. NO. F AG 9200 00 99

CABINET WITH SLIDING DOORS

ORD. NO.

F AF 1040 15 08

Complete with 4 drawers

2 retract. shelves, 2 tool holder frames

Dimensions mm 1431x632x1000 h

Tools and tool holders excluded

CABINET WITH LEAF DOORS

ORD. NO.

F AE 1040 14 50

Complete with

2 drawers, 2 retractable shelves

Dimensions mm 717x597x1000 h

Tools excluded

RAL 7000 F.01

RAL 6011 F.02

RAL 5012 F.04

RAL 7035 F.08

SUPPLEMENTARY PARTS ■

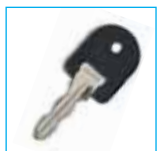
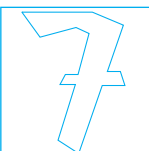

- **Spare key.** Always indicate the number on the cylinder lock of the key to be replaced.

ORD. NO. R CSC 0002 00

- **Master key.** This type of key opens all the 45 and 46 series locks.

ORD. NO. R CSC 0001 00



LENGTH = 717 mm DEPTH = 597/632 mm (36x27 Eh)

CABINETS SERIES STANDARD F27

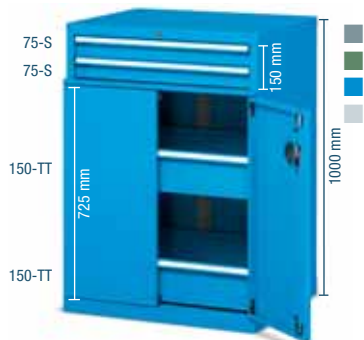

| ORD. NO. | DRAWERS |
|------------------------------|----------|
| F AE 1040 01 04 | 4 |
| Cabinet with 4 drawers | |
| Dimensions mm 717x597x1000 h | |
| Central lock | |



| ORD. NO. | DRAWERS |
|------------------------|----------|
| F AE 1040 10 04 | 3 |
| Cabinet with 3 drawers | |
| 2 retractable shelves | |
| Dim. mm 717x597x1000 h | |
| Central lock | |



| ORD. NO. | DRAWERS |
|------------------------|----------|
| F AE 1040 11 04 | 5 |
| Cabinet with 5 drawers | |
| 1 retractable shelf | |
| Dim. mm 717x597x1000 h | |
| Central lock | |

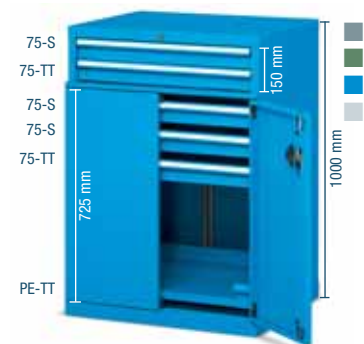

| ORD. NO. | DRAWERS |
|------------------------|----------|
| F AE 1040 12 04 | 5 |
| Cabinet with 5 drawers | |
| 1 retractable shelf | |
| Dim. mm 717x597x1000 h | |
| Central lock | |



| ORD. NO. | DRAWERS |
|------------------------------|----------|
| F AE 1040 13 04 | 4 |
| Cabinet with 4 drawers | |
| Dimensions mm 717x597x1000 h | |
| Central lock | |



| ORD. NO. | DRAWERS |
|------------------------|----------|
| F AE 1040 14 04 | 2 |
| Cabinet with 2 drawers | |
| 2 retractable shelves | |
| Dim. mm 717x597x1000 h | |
| Central lock | |

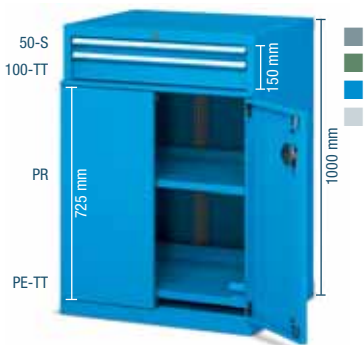

| ORD. NO. | DRAWERS |
|---|----------|
| F AE 1040 15 04 | 2 |
| Cabinet with 2 drawers | |
| 1 retractable shelf, 1 adjustable shelf | |
| Dim. mm 717x597x1000 h | |
| Central lock | |

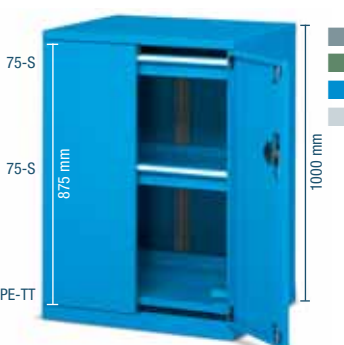

| ORD. NO. | DRAWERS |
|------------------------------|----------|
| F AE 2040 01 04 | 2 |
| Cabinet with 2 drawers | |
| 1 retractable shelf | |
| Dimensions mm 717x597x1000 h | |



| ORD. NO. | DRAWERS |
|------------------------------|----------|
| F AE 2040 03 04 | 4 |
| Cabinet with 4 drawers | |
| 1 retractable shelf | |
| Dimensions mm 717x597x1000 h | |

KEY

RAL 7000 F... ..01 RAL 6011 F... ..02 RAL 5012 F... ..04 RAL 7035 F... ..08



- TT = telescopic full extension (100%)
- PE-TT = full telescopic retractable shelf (100%)
- S = normal extension (87%)
- PR = height adjustable shelf

■ The cabinets must be secured to the floor or to the wall



CABINETS SERIES STANDARD F27

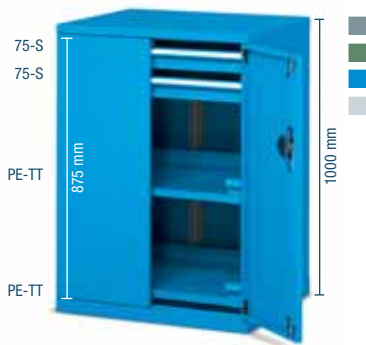

| ORD. NO. | DRAWERS |
|------------------------------|----------|
| F AE 2040 05 04 | 2 |
| Cabinet with 2 drawers | |
| 2 retractable shelves | |
| Dimensions mm 717x597x1000 h | |

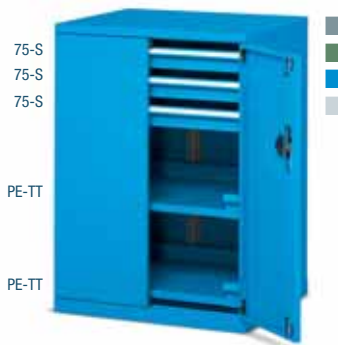

| ORD. NO. | DRAWERS |
|------------------------------|----------|
| F AE 2040 06 04 | 3 |
| Cabinet with 3 drawers | |
| 2 retractable shelves | |
| Dimensions mm 717x597x1000 h | |



| ORD. NO. | DRAWERS |
|------------------------------|----------|
| F AE 2040 07 04 | 4 |
| Cabinet with 4 drawers | |
| Dimensions mm 717x597x1000 h | |



| ORD. NO. | DRAWERS |
|------------------------------|----------|
| F AE 2040 10 04 | 2 |
| Cabinet with 2 drawers | |
| 1 retractable shelf | |
| Dimensions mm 717x597x1000 h | |



| ORD. NO. | DRAWERS |
|------------------------------|----------|
| F AE 2040 04 04 | 1 |
| Cabinet with 1 drawers | |
| 2 retractable shelves | |
| Dimensions mm 717x597x1000 h | |



| ORD. NO. | DRAWERS |
|------------------------------|----------|
| F AE 2040 11 04 | 3 |
| Cabinet with 3 drawers | |
| 1 retractable shelf | |
| Dimensions mm 717x597x1000 h | |

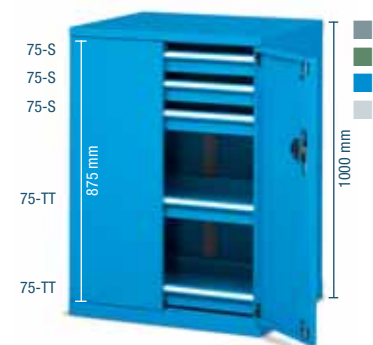

| ORD. NO. | DRAWERS |
|------------------------------|----------|
| F AE 2040 12 04 | 5 |
| Cabinet with 5 drawers | |
| Dimensions mm 717x597x1000 h | |



| ORD. NO. | SHELVES |
|---|----------|
| F AE 2040 13 04 | 2 |
| Cabinet with 2 retract. shelves, 1 adjustable shelf | |
| Dimensions mm 717x597x1000 h | |

RAL 7000 F... ..01 RAL 6011 F... ..02 RAL 5012 F... ..04 RAL 7035 F... ..08

KEY ■

■ The cabinets must be secured to the floor or to the wall

- TT = telescopic full extension (100%)
- PE-TT = full telescopic retractable shelf (100%)
- S = normal extension (87%)
- PE-S = normal retractable shelf (87%)
- PR = height adjustable shelf

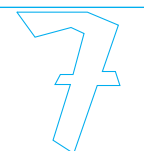

LENGTH = 717 mm DEPTH = 597/632 mm (36x27 Eh)

CABINETS SERIES STANDARD F27



RAL 7035

CABINET WITH SLIDING DOORS**ORD. NO.****F AF 1040 S1 08**

complete with 4 drawers, 2 retractable shelves,
2 tool holder frames,
1 rubber cover top with 3 edges

Dimensions mm 1431x632x1020 h

Tools and tool holders excluded



RAL 7000

CABINET WITH LEAF DOORS**ORD. NO.****F AE 2040 S1 01**

complete with 4 drawers, 2 tool holder frames,
1 rubber cover top with 3 edges

Dimensions mm 717x597x1020 h

Tools, tool holders and partitioning material excluded

KEY

RAL 7000 F... ..01

RAL 6011 F... ..02

RAL 5012 F... ..04

RAL 7035 F... ..08



- The cabinets must be secured to the floor or to the wall

■ Partitioning material: see page **A180**

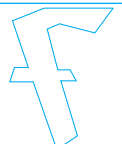

CABINETS SERIES STANDARD F27



•ORD. NO. DRAWERS
F AF 1040 06 04 2
 Cabinet with 2 drawers, 6 retractable shelves
 Dimensions mm 1431x632x1000 h



•ORD. NO. DRAWERS
F AF 1040 01 04 4
 Cabinet with 4 drawers, 2 retractable shelves
 Dimensions mm 1431x632x1000 h



•ORD. NO. DRAWERS
F AF 1040 02 04 6
 Cabinet with 6 drawers, 2 retractable shelves
 Dimensions mm 1431x632x1000 h



•ORD. NO. DRAWERS
F AF 1040 04 04 4
 Cabinet with 4 drawers, 4 retractable shelves
 Dimensions mm 1431x632x1000 h



•ORD. NO. DRAWERS
F AF 1040 13 04 8
 Cabinet with 8 drawers, 2 retractable shelves
 Dimensions mm 1431x632x1000 h



•ORD. NO. DRAWERS
F AF 1040 09 04 10
 Cabinet with 10 drawers
 Dimensions mm 1431x632x1000 h

RAL 7000 F... ..01 RAL 6011 F... ..02 RAL 5012 F... ..04 RAL 7035 F... ..08

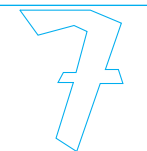

■ The cabinets must be secured to the floor or to the wall

KEY ■

- TT = telescopic full extension (100%)
- PE-TT = full telescopic retractable shelf (100%)
- S = normal extension (87%)



LENGTH = 717 mm DEPTH = 597/632 mm (36x27 Eh)

CABINETS SERIES STANDARD F27



| ORD. NO. | DRAWERS |
|---|----------|
| F AF 1040 10 04 | 4 |
| Cabinet with 4 drawers, 2 retractable shelves | |
| Dimensions mm 1431x632x1000 h | |

| ORD. NO. | SHELVES |
|--|----------|
| F AF 1040 14 04 | 6 |
| Cabinet with 4 retractable shelves, 2 adjustable shelves | |
| Dimensions mm 1431x632x1000 h | |



KEY



- TT = telescopic full extension (100%)
- PE-TT = full telescopic retractable shelf (100%)
- S = normal extension (87%)
- PR = height adjustable shelf

RAL 7000 F... ..01

RAL 6011 F... ..02

RAL 5012 F... ..04

RAL 7035 F... ..08

■ The cabinets must be secured to the floor or to the wall



CABINETS SERIES STANDARD F27

EMPTY CABINET (FB102)



■ 01
■ 02
■ 04
■ 08

ORD. NO. LOAD CAPACITY kg

F AE 1040 00 04 3000

Dimensions mm 717x597x1000 h

Usable height mm 150+725

Cabinet including 2 cylinder locks and 4 keys

ORD. NO.

R CSR 0003 00

Spare lock (for cabinet)

R CSR 0008 00

Spare lock (for door)

R XAE 0001 99

Pair of spare rod (for door)

EMPTY CABINET (FB100)



■ 01
■ 02
■ 04
■ 08

ORD. NO. LOAD CAPACITY kg

F AE 2040 00 04 3000

Dimensions mm 717x597x1000 h

Usable height mm 875

Cabinet including cylinder lock and 2 keys

ORD. NO.

R CSR 0008 00

Spare lock (for door)

R XAE 0002 99

Pair of spare rod (for door)

EMPTY CABINET (FD100)



■ 01
■ 02
■ 04
■ 08

ORD. NO. LOAD CAPACITY kg

F AF 1040 00 04 1500+1500

Dimensions mm 1431x632x1000 h

Usable height mm 875

Cabinet including cylinder lock and 2 keys

ORD. NO.

R CSR 0012 00

Spare lock (for door)

■ Spare key see page A150

■ The cabinet must be secured to the floor or to the wall. Further information for fixing set see page A150.

NORMAL EXTENSION DRAWERS (S)

| ORD. NO. | FRONT HEIGHT mm | LOAD CAPACITY kg | USABLE DIMENSIONS mm |
|------------------------|-----------------|------------------|----------------------|
| F FG 1005 00 04 | 50 | 60 | 600x447x36 h |
| F FG 1007 00 04 | 75 | 80 | 600x447x61 h |
| F FG 1010 00 04 | 100 | 100 | 600x447x86 h |
| F FG 1012 00 04 | 125 | 100 | 600x447x111 h |

Normale extension (87%)



■ 01
■ 02
■ 04
■ 08

■ Partitioning material: see page A80-A81

FULL TELESCOPIC EXTENSION DRAWERS (TT)

| ORD. NO. | FRONT HEIGHT mm | LOAD CAPACITY kg | USABLE DIMENSIONS mm |
|------------------------|-----------------|------------------|----------------------|
| F FG 1107 00 04 | 75 | 200 | 600x447x54 h |
| F FG 1110 00 04 | 100 | 200 | 600x447x79 h |
| F FG 1112 00 04 | 125 | 200 | 600x447x104 h |
| F FG 1115 00 04 | 150 | 200 | 600x447x129 h |
| F FG 1120 00 04 | 200 | 200 | 600x447x179 h |
| F FG 1125 00 04 | 250 | 200 | 600x447x229 h |
| F FG 1130 00 04 | 300 | 200 | 600x447x279 h |

Full telescopic extension (100%)

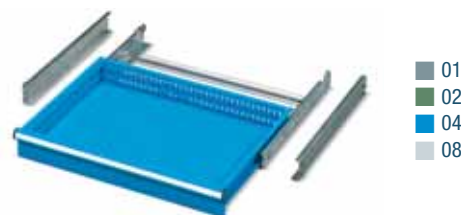

■ 01
■ 02
■ 04
■ 08

■ Partitioning material: see page A80-A81

NORMAL EXTENSION SHELVES (PE-S)

| ORD. NO. | SIDE HEIGHT mm | LOAD CAPACITY kg | USABLE DIMENSIONS mm |
|------------------------|----------------|------------------|----------------------|
| F FG 8010 00 04 | - | 100 | 610x459 |

Normale extension (87%)



■ 01
■ 02
■ 04
■ 08

FULL TELESCOPIC EXTENSION SHELVES (PE-TT)

| ORD. NO. | SIDE HEIGHT mm | LOAD CAPACITY kg | USABLE DIMENSIONS mm |
|------------------------|----------------|------------------|----------------------|
| F FG 8110 00 04 | - | 200 | 610x459 |

Full telescopic extension (100%)



■ 01
■ 02
■ 04
■ 08

ADJUSTABLE SHELVES

| ORD. NO. | SIDE HEIGHT mm | LOAD CAPACITY kg | USABLE DIMENSIONS mm |
|------------------------|----------------|------------------|----------------------|
| F SR 1210 01 04 | 25 | 150 | 655x460 |

Without extension system



■ 01
■ 02
■ 04
■ 08

LENGTH = 717 mm DEPTH = 597/632 mm (36x27 Eh)

CABINETS SERIES STANDARD F27

CABINET TO CABINET FIXING

■ The article includes:
4 M8 nuts and bolts.
Suitable for fixing same
series cabinets only.

ORD. NO. F AG 9202 00 99

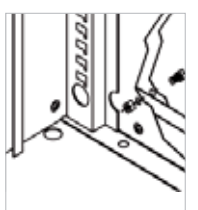

TWO SIDED ADHESIVE TAPE

ORD. NO.

R CMV 0025 00

width 15 mm
length 50 metres



■ 07

PLINTHS

For cabinet F AE 1040 - F AE 2040

ORD. NO.

F RR 0060 00 07

Plinths height 50 mm



■ 07

PLINTHS

For cabinet F AF 1040

ORD. NO.

F RR 0110 00 07

Plinths height 50 mm



■ 07

PLINTHS FOR TRANSPALLET

For cabinet F AE 1040 - F AE 2040

ORD. NO.

F RR 0305 00 07 Plinths height 100 mm

F RR 0405 00 07 Facing piece



■ 07

PLINTHS FOR TRANSPALLET

For cabinet F AF 1040

ORD. NO.

F RR 0225 00 07

Pair of plinths height 100 mm

F RR 0445 00 07

Facing piece

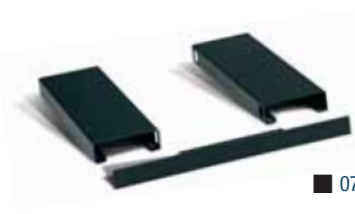

■ 07

PLINTHS FOR FORK LIFT TRUCK

For cabinet F AE 1040 - F AE 2040

ORD. NO.

F RR 0210 00 07

Pair of plinths height 60 mm

F RR 0400 00 07

Facing piece



■ 07

PLINTHS FOR FORK LIFT TRUCK

For cabinet F AF 1040

ORD. NO.

F RR 0220 00 07

Pair of plinths height 60 mm

F RR 0440 00 07

Facing piece



■ 07

TOP SHELF

For cabinet F AE 1040

ORD. NO.

DIMENSIONS mm

F AG 9000 01 07

717x573x20 h

oil-resistant rubber cover top with 3 edges



■ 07

TOP SHELF

For cabinet F AE 2040

ORD. NO.

DIMENSIONS mm

F AE 9003 01 07

717x597x20 h

oil-resistant rubber cover top with 3 edges



■ 07

TOP SHELF

For cabinet F AF 1040

ORD. NO.

DIMENSIONS mm

F AF 9000 01 07

1431x630x20 h

oil-resistant rubber cover top with 3 edges

■ INFO



www.famispaspa.com



CABINETS SERIES STANDARD F36



ORD. NO. F AE 4058 14 01
RAL 7000

ORD. NO. F AF 3040 17 08
RAL 7035

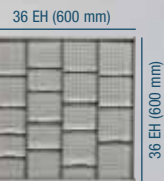

FLOOR FIXING SET



2x

- 2 "HILTI" plugs for concrete floors \geq to classes B25/RBK250/MPa 25 N/mm²
- Recommended traction of the plug: 2.9 KN
- Plug diameter: \varnothing 6 mm

ORD. NO. F AG 9204 00 99

CABINET FLOOR FIXING SET

- Pair of spare galvanised brackets
- \varnothing 6 mm hole



ORD. NO. F AG 9200 00 99

CABINET WITH SLIDING DOORS
ORD. NO.

F AF 3040 17 08

- Complete with 4 drawers
- 2 retractable shelves
- 2 tool holder frames

Dimensions mm 1431x785x1000 h

Tools and tool holders excluded

CABINET WITH LEAF DOORS
ORD. NO.

F AE 4058 14 01

- Complete with 3 drawers
- 2 retractable shelves
- 1 tool holder frame

Dimensions mm 717x750x1450 h

Tools and tool holders excluded

RAL 7000 F... ..01 RAL 6011 F... ..02 RAL 5012 F... ..04 RAL 7035 F... ..08

SUPPLEMENTARY PARTS ■

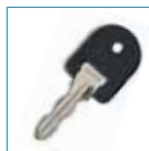
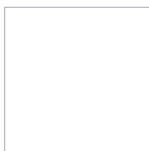
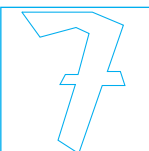

- **Spare key.** Always indicate the number on the cylinder lock of the key to be replaced.
ORD. NO. R CSC 0002 00
- **Master key.** This type of key opens all the 45 and 46 series locks.
ORD. NO. R CSC 0001 00



LENGTH = 717 mm DEPTH = 750/785 mm (36x36 Eh)

CABINETS SERIES STANDARD F36

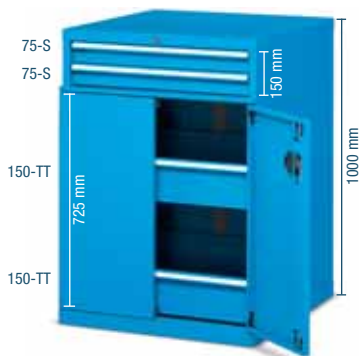

| ORD. NO. | DRAWERS |
|------------------------------|----------|
| F AE 3040 01 04 | 4 |
| Cabinet with 4 drawers | |
| Dimensions mm 717x750x1000 h | |
| Central lock | |



| ORD. NO. | DRAWERS |
|------------------------|----------|
| F AE 3040 11 04 | 3 |
| Cabinet with 3 drawers | |
| 2 retractable shelves | |
| Dim. mm 717x750x1000 h | |
| Central lock | |



| ORD. NO. | DRAWERS |
|------------------------|----------|
| F AE 3040 12 04 | 5 |
| Cabinet with 5 drawers | |
| 1 retractable shelf | |
| Dim. mm 717x750x1000 h | |
| Central lock | |



| ORD. NO. | DRAWERS |
|------------------------|----------|
| F AE 3040 13 04 | 5 |
| Cabinet with 5 drawers | |
| 1 retractable shelf | |
| Dim. mm 717x750x1000 h | |
| Central lock | |



| ORD. NO. | DRAWERS |
|------------------------------|----------|
| F AE 3040 14 04 | 4 |
| Cabinet with 4 drawers | |
| Dimensions mm 717x750x1000 h | |
| Central lock | |



| ORD. NO. | DRAWERS |
|------------------------|----------|
| F AE 3040 15 04 | 2 |
| Cabinet with 2 drawers | |
| 2 retractable shelves | |
| Dim. mm 717x750x1000 h | |
| Central lock | |



| ORD. NO. | DRAWERS |
|---|----------|
| F AE 3040 17 04 | 2 |
| Cabinet with 2 drawers | |
| 1 retractable shelf, 1 adjustable shelf | |
| Dim. mm 717x750x1000 h | |
| Central lock | |

RAL 7035 +
RAL 5012



CABINET WITH LEAF DOORS

| ORD. NO. |
|---|
| F AE 3040 S1 50 |
| complete with 4 drawers, 2 tool holder frames with supports, 1 rubber cover MDF top |
| Dimensions mm 717x750x1030 h |
| Tools and tool holders excluded. |

KEY

RAL 7000 F... ..01 RAL 6011 F... ..02 RAL 5012 F... ..04 RAL 7035 F... ..08



- TT = telescopic full extension (100%)
- PE-TT = full telescopic retractable shelf (100%)
- S = normal extension (87%)
- PR = height adjustable shelf

■ The cabinets must be secured to the floor or to the wall



CABINETS SERIES STANDARD F36

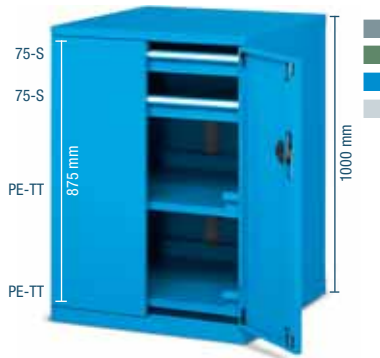

| ORD. NO. | DRAWERS |
|------------------------------|----------|
| F AE 4040 01 04 | 2 |
| Cabinet with 2 drawers | |
| 2 retractable shelves | |
| Dimensions mm 717x750x1000 h | |



| ORD. NO. | DRAWERS |
|------------------------------|----------|
| F AE 4040 08 04 | 6 |
| Cabinet with 6 drawers | |
| Dimensions mm 717x750x1000 h | |



| ORD. NO. | DRAWERS |
|------------------------------|----------|
| F AE 4040 09 04 | 3 |
| Cabinet with 3 drawers | |
| Dimensions mm 717x750x1000 h | |

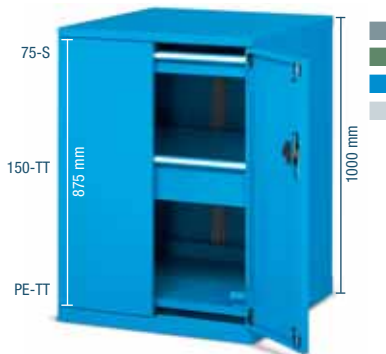

| ORD. NO. | DRAWERS |
|------------------------------|----------|
| F AE 4040 10 04 | 2 |
| Cabinet with 2 drawers | |
| 1 retractable shelf | |
| Dimensions mm 717x750x1000 h | |



| ORD. NO. | DRAWERS |
|------------------------------|----------|
| F AE 4040 11 04 | 2 |
| Cabinet with 2 drawers | |
| 1 retractable shelf | |
| Dimensions mm 717x750x1000 h | |



| ORD. NO. | DRAWERS |
|------------------------------|----------|
| F AE 4040 12 04 | 3 |
| Cabinet with 3 drawers | |
| 1 retractable shelf | |
| Dimensions mm 717x750x1000 h | |

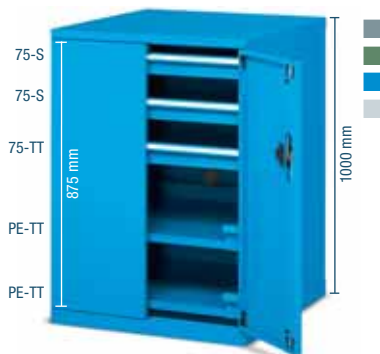

| ORD. NO. | DRAWERS |
|------------------------------|----------|
| F AE 4040 13 04 | 3 |
| Cabinet with 3 drawers | |
| 2 retractable shelves | |
| Dimensions mm 717x750x1000 h | |



| ORD. NO. | DRAWERS |
|------------------------------|----------|
| F AE 4040 14 04 | 4 |
| Cabinet with 4 drawers | |
| 1 retractable shelf | |
| Dimensions mm 717x750x1000 h | |



| ORD. NO. | DRAWERS |
|------------------------------|----------|
| F AE 4040 15 04 | 3 |
| Cabinet with 3 drawers | |
| Dimensions mm 717x750x1000 h | |

RAL 7000 F.01 RAL 6011 F.02 RAL 5012 F.04

RAL 7035 F.08

KEY ■

■ The cabinets must be secured to the floor or to the wall

- TT = telescopic full extension (100%)
- PE-TT = full telescopic retractable shelf (100%)
- S = normal extension (87%)



LENGTH = 717 mm DEPTH = 750/785 mm (36x36 Eh)

CABINETS SERIES STANDARD F36



| ORD. NO. | DRAWERS |
|------------------------------|----------|
| F AE 4058 02 04 | 5 |
| Cabinet with 5 drawers | |
| Dimensions mm 717x750x1450 h | |



| ORD. NO. | DRAWERS |
|---|----------|
| F AE 4058 04 04 | 4 |
| Cabinet with 4 drawers, 2 retractable shelves | |
| Dimensions mm 717x750x1450 h | |



| ORD. NO. | DRAWERS |
|---|----------|
| F AE 4058 08 04 | 3 |
| Cabinet with 3 drawers, 2 retractable shelves | |
| Dimensions mm 717x750x1450 h | |



| ORD. NO. | DRAWERS |
|------------------------------|----------|
| F AE 4058 12 04 | 8 |
| Cabinet with 8 drawers | |
| Dimensions mm 717x750x1450 h | |

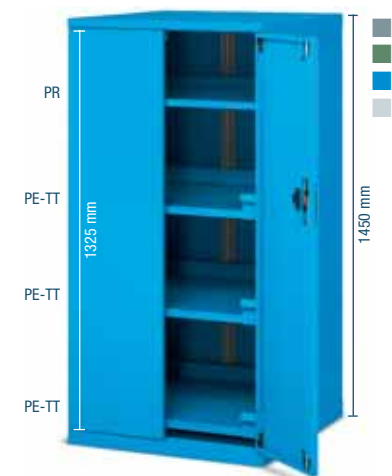

| ORD. NO. | SHELVES |
|--|----------|
| F AE 4058 10 04 | 4 |
| Cabinet with 3 retractable shelves, 1 adjustable shelf | |
| Dimensions mm 717x750x1450 h | |



CABINET WITH LEAF DOORS

| ORD. NO. |
|--|
| F AE 4058 S1 01 |
| complete with 3 drawers, 2 retractable shelves, 1 tool holder frame, 1 rubber cover top with 3 edges |
| Dim. mm 717x750x1470 h Tools and tool holders excluded |

KEY

RAL 7000 F... ..01 RAL 6011 F... ..02 RAL 5012 F... ..04 RAL 7035 F... ..08



- TT = telescopic full extension (100%)
- PE-TT = full telescopic retractable shelf (100%)
- S = normal extension (87%)
- PR = height adjustable shelf

■ The cabinets must be secured to the floor or to the wall



CABINETS SERIES STANDARD F36



•ORD. NO. DRAWERS
F AF 3040 04 04 4
 Cabinet with 4 drawers, 4 retractable shelves
 Dimensions mm 1431x785x1000 h



•ORD. NO. DRAWERS
F AF 3040 06 04 6
 Cabinet with 6 drawers
 Dimensions mm 1431x785x1000 h



ORD. NO. DRAWERS
F AF 3040 10 04 4
 Cabinet with 4 drawers, 2 retractable shelves
 Dimensions mm 1431x785x1000 h



•ORD. NO. DRAWERS
F AF 3040 12 04 12
 Cabinet with 12 drawers
 Dimensions mm 1431x785x1000 h



•ORD. NO. DRAWERS
F AF 3040 14 04 8
 Cabinet with 8 drawers, 2 retractable shelves
 Dimensions mm 1431x785x1000 h



•ORD. NO. DRAWERS
F AF 3040 13 04 8
 Cabinet with 8 drawers
 Dimensions mm 1431x785x1000 h

RAL 7000 F.01 RAL 6011 F.02 RAL 5012 F.04 RAL 7035 F.08

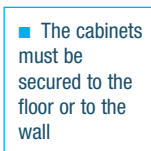
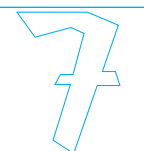

KEY ■

- TT = telescopic full extension (100%)
- PE-TT = full telescopic retractable shelf (100%)
- S = normal extension (87%)



■ The cabinets must be secured to the floor or to the wall

LENGTH = 717 mm DEPTH = 750/785 mm (36x36 Eh)

CABINETS SERIES STANDARD F36



| ORD. NO. | DRAWERS |
|---|----------|
| F AF 3040 15 04 | 2 |
| Cabinet with 2 drawers, 6 retractable shelves | |
| Dimensions mm 1431x785x1000 h | |

CABINET WITH SLIDING DOORS

| ORD. NO. |
|--|
| F AF 3040 S1 08 |
| complete with 4 drawers, 2 retractable shelves |
| 2 tool holder frames |
| 1 rubber cover top with 3 edges |
| Dimensions mm 1431x785x1020 h |
| Tools and tool holders excluded |



KEY



- PE-TT = full telescopic retractable shelf (100%)
- S = normal extension (87%)

RAL 7000 F... ..01 RAL 6011 F... ..02 RAL 5012 F... ..04 RAL 7035 F... ..08

■ The cabinets must be secured to the floor or to the wall

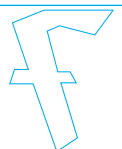

CABINETS SERIES STANDARD F36

EMPTY CABINET (FA100)



■ 01
■ 02
■ 04
■ 08

ORD. NO. LOAD CAPACITY kg

F AE 3040 00 04 3000

Dimensions mm 717x750x1000 h

Usable height mm 150+725

Cabinet including 2 cylinder locks and 4 keys

ORD. NO.

R CSR 0003 00

Spare lock (for cabinet)

R CSR 0008 00

Spare lock (for door)

R XAE 0001 99

Pair of spare rod (for door)

EMPTY CABINET (F100 - F145)



■ 01
■ 02
■ 04
■ 08

ORD. NO. LOAD CAPACITY kg

F AE 4040 00 04 3000

Dimensions mm 717x750x1000 h

Usable height mm 875

F AE 4058 00 04 3000

Dimensions mm 717x750x1450 h

Usable height mm 1325

Cabinet including cylinder lock and 2 keys

ORD. NO.

R CSR 0008 00

Spare lock (for door)

R XAE 0002 99

Pair of spare rod (for door) cabinet F AE 4040

R XAE 0003 99

Pair of spare rod (for door) cabinet F AE 4058

EMPTY CABINET (FC100)



■ 01
■ 02
■ 04
■ 08

ORD. NO. LOAD CAPACITY kg

F AF 3040 00 04 1500+1500

Dimensions mm 1431x785x1000 h

Usable height mm 875

Cabinet including cylinder lock and 2 keys

ORD. NO.

R CSR 0012 00

Spare lock (for door)

■ Spare key see page A158

■ The cabinet must be secured to the floor or to the wall. Further information for fixing set see page A158.

NORMAL EXTENSION DRAWERS (S)

| ORD. NO. | FRONT HEIGHT mm | LOAD CAPACITY kg | USABLE DIMENSIONS mm |
|------------------------|-----------------|------------------|----------------------|
| F FG 2005 00 04 | 50 | 60 | 600x600x36 h |
| F FG 2007 00 04 | 75 | 80 | 600x600x61 h |
| F FG 2010 00 04 | 100 | 100 | 600x600x86 h |
| F FG 2012 00 04 | 125 | 100 | 600x600x111 h |
| F FG 2015 00 04 | 150 | 100 | 600x600x136 h |
| F FG 2017 00 04 | 175 | 100 | 600x600x161 h |
| F FG 2020 00 04 | 200 | 100 | 600x600x186 h |
| F FG 2030 00 04 | 300 | 100 | 600x600x286 h |

Normal extension (87%)



■ 01
■ 02
■ 04
■ 08

■ Partitioning material: see page A96-A97

FULL TELESCOPIC EXTENSION DRAWERS (TT)

| ORD. NO. | FRONT HEIGHT mm | LOAD CAPACITY kg | USABLE DIMENSIONS mm |
|------------------------|-----------------|------------------|----------------------|
| F FG 2107 00 04 | 75 | 200 | 600x600x54 h |
| F FG 2110 00 04 | 100 | 200 | 600x600x79 h |
| F FG 2112 00 04 | 125 | 200 | 600x600x104 h |
| F FG 2115 00 04 | 150 | 200 | 600x600x129 h |
| F FG 2117 00 04 | 175 | 200 | 600x600x154 h |
| F FG 2120 00 04 | 200 | 200 | 600x600x179 h |
| F FG 2125 00 04 | 250 | 200 | 600x600x229 h |
| F FG 2130 00 04 | 300 | 200 | 600x600x279 h |
| F FG 2140 00 04 | 400 | 200 | 600x600x379 h |

Full telescopic extension (100%)



■ 01
■ 02
■ 04
■ 08

■ Partitioning material: see page A96-A97

NORMAL EXTENSION SHELVES (PE-S)

| ORD. NO. | SIDE HEIGHT mm | LOAD CAPACITY kg | USABLE DIMENSIONS mm |
|------------------------|----------------|------------------|----------------------|
| F FG 8020 00 04 | - | 100 | 610x610 |

Normal extension (87%)



■ 01
■ 02
■ 04
■ 08

LENGTH = 717 mm DEPTH = 750/785 mm (36x36 Eh)

CABINETS SERIES STANDARD F36

FULL TELESCOPIC EXTENSION SHELVES (PE-TT)

| ORD. NO. | SIDE HEIGHT mm | LOAD CAPACITY kg | USABLE DIMENSIONS mm |
|-----------------|----------------|------------------|----------------------|
| F FG 8120 00 04 | - | 200 | 610x610 |

Full telescopic extension (100%)



ADJUSTABLE SHELVES

| ORD. NO. | SIDE HEIGHT mm | LOAD CAPACITY kg | USABLE DIMENSIONS mm |
|-----------------|----------------|------------------|----------------------|
| F SR 1260 01 04 | 25 | 150 | 618x618 |

Without extension system



CABINET TO CABINET FIXING

■ The article includes:
4 M8 nuts and bolts.
Suitable for fixing same series cabinets only.

ORD. NO. F AG 9202 00 99

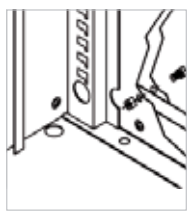

TWO SIDED ADHESIVE TAPE

ORD. NO.

R CMV 0025 00

width 15 mm
length 50 metres



■ 07

PLINTHS

For cabinet F AE 3040 - F AE 4040 - F AE 4058

ORD. NO.

F RR 0080 00 07

Plinths height 50 mm



■ 07

PLINTHS

For cabinet F AF 3040

ORD. NO.

F RR 0145 00 07

Plinths height 50 mm



■ 07

PLINTHS FOR TRANSPALLET

For cabinet F AE 3040 - F AE 4040 - F AE 4058

ORD. NO.

F RR 0315 00 07 Plinths height 100 mm

F RR 0405 00 07 Facing piece



■ 07

PLINTHS FOR TRANSPALLET

For cabinet F AF 3040

ORD. NO.

F RR 0255 00 07 Pair of plinths height 100 mm

F RR 0445 00 07 Facing piece



■ 07

PLINTHS FOR FORK LIFT TRUCK

For cabinet F AE 3040 - F AE 4040 - F AE 4058

ORD. NO.

F RR 0240 00 07 Pair of plinths height 60 mm

F RR 0400 00 07 Facing piece



■ 07

PLINTHS FOR FORK LIFT TRUCK

For cabinet F AF 3040

ORD. NO.

F RR 0250 00 07 Pair of plinths height 60 mm

F RR 0440 00 07 Facing piece



■ 07

TOP SHELF

For cabinet F AE 3040

ORD. NO.

F AG 9003 01 07 717x726x20 h

oil-resistant rubber cover top with 3 edges

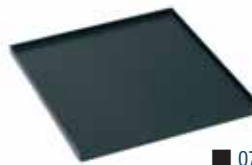

■ 07

TOP SHELF

For cabinet F AE 4040 - F AE 4058

ORD. NO.

F AE 9009 01 07 717x750x20 h

oil-resistant rubber cover top with 3 edges



■ 07

TOP SHELF

For cabinet F AF 3040

ORD. NO.

F AF 9006 01 07 1431x785x20 h

oil-resistant rubber cover top with 3 edges



36 EH (600 mm)

36 EH (600 mm)



ORD. NO. F AE 8058 21 04

FLOOR FIXING SET

2x

- 2 "HILTI" plugs for concrete floors \geq to classes B25/RBK250/MPA 25 N/mm²
- Recommended traction of the plug: 2.9 KN
- Plug diameter: \varnothing 6 mm

ORD. NO. F AG 9204 00 99

CABINET FLOOR FIXING SET

- Pair of spare galvanised brackets
- \varnothing 6 mm hole



ORD. NO. F AG 9200 00 99

RAL 7000 F... ..01

RAL 6011 F... ..02

RAL 5012 F... ..04

RAL 7035 F... ..08

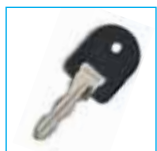
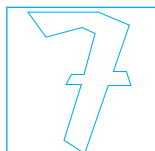
SUPPLEMENTARY PARTS ■

- **Spare key.** Always indicate the number on the cylinder lock of the key to be replaced.

ORD. NO. R CSC 0002 00

- **Master key.** This type of key opens all the 45 and 46 series locks.

ORD. NO. R CSC 0001 00



LENGTH = 717 mm DEPTH = 750 mm (36x36 Eh)

CABINETS SERIES STANDARD FO



| ORD. NO. | SHELVES |
|------------------------|----------|
| F AE 8058 01 04 | 2 |

Cabinet complete with: 2 full extension retractable shelves (200 kg), 4 plastic cans 25 litres capacity, 5 plastic cans 10 litres capacity, 1 retractable safety tank for oil 40 litres capacity.

| | |
|---------------------------------------|------------|
| Total useful capacity of the cabinet: | 150 litres |
| Capacity of safety tank for oil: | 40 litres |

Dimensions mm 717x750x1450 h



| ORD. NO. | SHELVES |
|------------------------|----------|
| F AE 8058 21 04 | 2 |

Cabinet complete with: 2 full extension retractable shelves (200 kg), 4 plastic cans 25 litres capacity, 5 plastic cans 10 litres capacity, 1 plastic drip tray 10 litres capacity, 1 safety tank for oil 77 litres capacity, 2 plugs for tank.

| | |
|---------------------------------------|------------|
| Total useful capacity of the cabinet: | 150 litres |
| Capacity of safety tank for oil: | 77 litres |

Dimensions mm 717x750x1600 h



| ORD. NO. | SHELVES |
|------------------------|----------|
| F AE 8058 41 04 | 2 |

Cabinet complete with: 2 full extension retractable shelves (200 kg), 4 plastic cans 25 litres capacity, 5 plastic cans 10 litres capacity, 1 retractable safety tank for oil 40 litres capacity, 1 safety tank for oil 77 litres capacity, 2 plugs for tank.

| | |
|---|------------|
| Total useful capacity of the cabinet: | 150 litres |
| Total capacity of safety tanks for oil: | 117 litres |

Dimensions mm 717x750x1600 h



| ORD. NO. | SHELVES |
|------------------------|----------|
| F AE 8058 02 04 | 3 |

Cabinet complete with: 3 full extension retractable shelves (200 kg), 4 plastic cans 25 litres capacity, 10 plastic cans 10 litres capacity, 1 retractable safety tank for oil 40 litres capacity.

| | |
|---------------------------------------|------------|
| Total useful capacity of the cabinet: | 200 litres |
| Capacity of safety tank for oil: | 40 litres |

Dimensions mm 717x750x1450 h



| ORD. NO. | SHELVES |
|------------------------|----------|
| F AE 8058 22 04 | 3 |

Cabinet complete with: 3 full extension retractable shelves (200 kg), 4 plastic cans 25 litres capacity, 10 plastic cans 10 litres capacity, 1 plastic drip tray 10 litres capacity, 1 safety tank for oil 77 litres capacity, 2 plugs for tank.

| | |
|---------------------------------------|------------|
| Total useful capacity of the cabinet: | 200 litres |
| Capacity of safety tank for oil: | 77 litres |

Dimensions mm 717x750x1600 h



| ORD. NO. | SHELVES |
|------------------------|----------|
| F AE 8058 42 04 | 3 |

Cabinet complete with: 3 full extension retractable shelves (200 kg), 4 plastic cans 25 litres capacity, 10 plastic cans 10 litres capacity, 1 retractable safety tank for oil 40 litres capacity, 1 safety tank for oil 77 litres capacity, 2 plugs for tank.

| | |
|---|------------|
| Total useful capacity of the cabinet: | 200 litres |
| Total capacity of safety tanks for oil: | 117 litres |

Dimensions mm 717x750x1600 h

■ KEY

RAL 7000 F.01

RAL 6011 F.02

RAL 5012 F.04

RAL 7035 F.08



■ The cabinets must be secured to the floor or to the wall



LENGTH = 717 mm DEPTH = 750 mm (36x36 Eh)

CABINETS SERIES STANDARD FO



| ORD. NO. | SHELVES |
|--|------------|
| F AE 8058 03 04 | 2 |
| Cabinet complete with: | |
| 2 full extension retractable shelves (200 kg), | |
| 8 plastic cans 25 litres capacity, | |
| 1 retractable safety tank for oil 40 litres capacity | |
| Total useful capacity of the cabinet: | 200 litres |
| Capacity of safety tank for oil: | 40 litres |
| Dimensions mm 717x750x1450 h | |

| ORD. NO. | SHELVES |
|--|------------|
| F AE 8058 23 04 | 2 |
| Cabinet complete with: 2 full extension retractable | |
| shelves (200 kg), 8 plastic cans 25 litres capacity, | |
| 1 plastic drip tray 10 litres capacity, | |
| 1 safety tank for oil 77 litres capacity, | |
| 2 plugs for tank. | |
| Total useful capacity of the cabinet: | 200 litres |
| Capacity of safety tank for oil: | 77 litres |
| Dimensions mm 717x750x1600 h | |

| ORD. NO. | SHELVES |
|---|------------|
| F AE 8058 43 04 | 2 |
| Cabinet complete with: 2 full extension retractable | |
| shelves (200 kg), 8 plastic cans 25 litres capacity, | |
| 1 retractable safety tank for oil 40 litres capacity, | |
| 1 safety tank for oil 77 litres capacity, 2 plugs for tank. | |
| Total useful capacity of the cabinet: | 200 litres |
| Total capacity of safety tanks for oil: | 117 litres |
| Dimensions mm 717x750x1600 h | |



RAL 7000 F.01 RAL 6011 F.02 RAL 5012 F.04 RAL 7035 F.08

KEY ■

■ The cabinets must be secured to the floor or to the wall



LENGTH = 717 mm DEPTH = 750 mm (36x36 Eh)

CABINETS SERIES STANDARD FO

**ORD. NO.****SHELVES****F AE 8058 04 04****4**

Cabinet complete with:
 4 full extension retractable shelves (200 kg),
 20 plastic cans 10 litres capacity,
 1 retractable safety tank for oil 23 litres capacity

| | |
|---------------------------------------|------------|
| Total useful capacity of the cabinet: | 200 litres |
|---------------------------------------|------------|

| | |
|----------------------------------|-----------|
| Capacity of safety tank for oil: | 23 litres |
|----------------------------------|-----------|

Dimensions mm 717x750x1450 h**ORD. NO.****SHELVES****F AE 8058 24 04****4**

Cabinet complete with: 4 full extension retractable shelves (200 kg), 20 plastic cans 10 litres capacity, 1 plastic drip tray 10 litres capacity, 1 safety tank for oil 77 litres capacity, 2 plugs for tank.

| | |
|---------------------------------------|------------|
| Total useful capacity of the cabinet: | 200 litres |
|---------------------------------------|------------|

| | |
|----------------------------------|-----------|
| Capacity of safety tank for oil: | 77 litres |
|----------------------------------|-----------|

Dimensions mm 717x750x1600 h**ORD. NO.****SHELVES****F AE 8058 44 04****4**

Cabinet complete with: 4 full extension retractable shelves (200 kg), 20 plastic cans 10 litres capacity, 1 retractable safety tank for oil 23 litres capacity, 1 safety tank for oil holding 77 litres, 2 plugs for tank.

| | |
|---------------------------------------|------------|
| Total useful capacity of the cabinet: | 200 litres |
|---------------------------------------|------------|

| | |
|---|------------|
| Total capacity of safety tanks for oil: | 100 litres |
|---|------------|

Dimensions mm 717x750x1600 h**KEY**

RAL 7000 F... ..01

RAL 6011 F... ..02

RAL 5012 F... ..04

RAL 7035 F... ..08



- The cabinets must be secured to the floor or to the wall



CABINETS SERIES STANDARD FO



| ORD. NO. | SHELVES |
|---|------------|
| F AE 8058 05 04 | 3 |
| Cabinet complete with: 2 full extension retractable shelves (200 kg), 4 plastic cans 25 litres capacity, 5 plastic cans 10 litres capacity, 1 height adjustable shelf (150 kg) 618 mm deep, 1 retractable safety tank for oil 40 litres capacity. | |
| Total useful capacity of the cabinet: | 150 litres |
| Capacity of safety tank for oil: | 40 litres |
| Dimensions mm 717x750x1450 h | |

| ORD. NO. | SHELVES |
|---|------------|
| F AE 8058 25 04 | 3 |
| Cabinet complete with: 2 full extension retractable shelves (200 kg), 4 plastic cans 25 litres capacity, 5 plastic cans 10 litres capacity, 1 height adjustable shelf (150 kg) 618 mm deep, 1 plastic drip tray 10 litres capacity, 1 safety tank for oil 77 litres capacity, 2 plugs for tank. | |
| Total useful capacity of the cabinet: | 150 litres |
| Capacity of safety tank for oil: | 77 litres |
| Dimensions mm 717x750x1600 h | |

| ORD. NO. | SHELVES |
|---|------------|
| F AE 8058 45 04 | 3 |
| Cabinet complete with: 2 full extension retractable shelves (200 kg), 4 plastic cans 25 litres capacity, 5 plastic cans 10 litres capacity, 1 height adjustable shelf (150 kg) 618 mm deep, 1 retractable safety tank for oil 40 litres capacity, 1 safety tank for oil 77 litres capacity, 2 plugs for tank. | |
| Total useful capacity of the cabinet: | 150 litres |
| Total capacity of safety tanks for oil: | 117 litres |
| Dimensions mm 717x750x1600 h | |



ORD. NO. F AE 8058 42 04



ORD. NO. F AE 8058 25 04

RAL 7000 F... ..01

RAL 6011 F... ..02

RAL 5012 F... ..04

RAL 7035 F... ..08

SUPPLEMENTARY PARTS ■



■ The cabinets must be secured to the floor or to the wall



■ **Spare key.** Always indicate the number on the cylinder lock of the key to be replaced.

ORD. NO. R CSC 0002 00

■ **Master key.** This type of key opens all the 45 and 46 series locks.

ORD. NO. R CSC 0001 00



LENGTH = 717 mm DEPTH = 750 mm (36x36 Eh)

CABINETS SERIES STANDARD FO



■ INFO

RAL 7000 F.01

RAL 6011 F.02

RAL 5012 F.04

RAL 7035 F.08



www.famispa.com

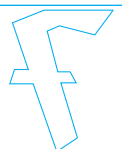

CABINETS SERIES STANDARD CS



FLOOR FIXING SET



2x

- 2 "HILTI" plugs for concrete floors \geq to classes B25/RBK250/MP_A 25 N/mm²
- Recommended traction of the plug: 2.9 KN
- Plug diameter: \varnothing 6 mm

ORD. NO. F AG 9204 00 99

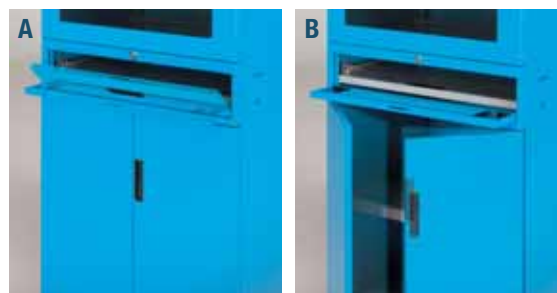

The lock on the door in figure **A** closes or opens the lower door in figure **B** at the same time

RAL 7000 F.01

RAL 6011 F.02

RAL 5012 F.04

RAL 7035 F.08

SUPPLEMENTARY PARTS ■

■ **Spare key.** Always indicate the number on the cylinder lock of the key to be replaced.

ORD. NO. R CSC 0002 00

■ **Master key.** This type of key opens all the 45 and 46 series locks.

ORD. NO. R CSC 0001 00



LENGTH = 717 mm DEPTH = 635 mm

CABINETS SERIES STANDARD CS

Polycarbonate door with safety lock. Useful dimensions: 660x525 mm h.

Suitable for monitor sizes up to 21". Internal dimensions of upper compartment: 690x600x580 mm h.

Retractable keyboard shelf. Useful dimensions: 620x510 mm h.

The lower compartment can be fitted with retractable and height adjustable shelves for housing hardware systems and printers. Internal dimensions : 690x600x720 mm h.

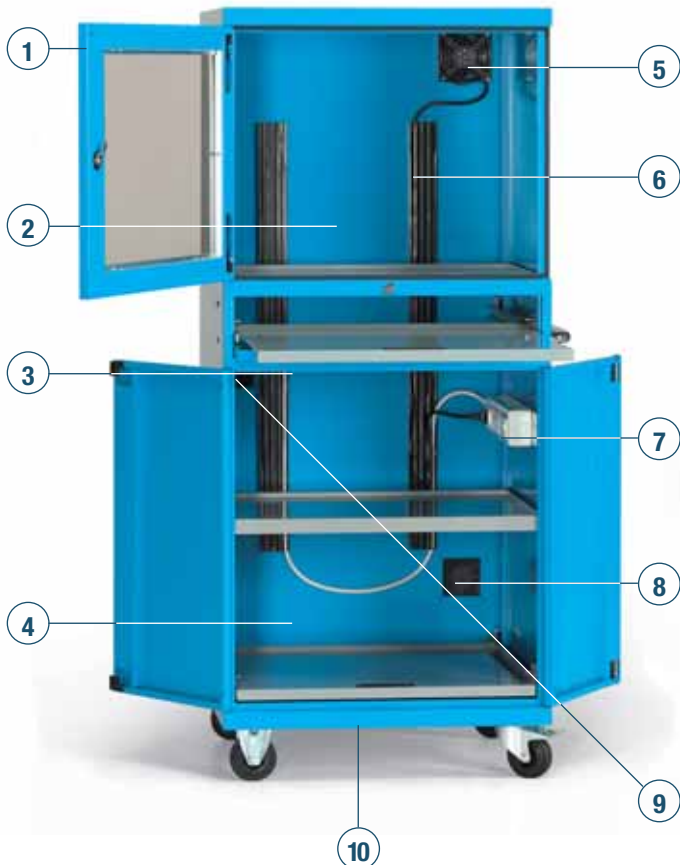

5 Cooling fan with dust filter.

6 4-channel cable duct.

7 5-socket electrical system with circuit breaker.

8 Air inlet hole with dust filter.

9 Inlet hole for network cables and outlet hole for power cable.

Room temperature for use -5/+40 °C with umidity up to 50%
Room temperature for use -5/+20 °C with umidity up to 90%

3 The retractable keyboard shelf can be locked in two different positions and it is generously sized to make place for work accessories and make it more comfortable to use the keyboard. 1 mouse pad, 2 floor brackets, 12 plastic caps and 2 levelling devices are supplied standard with the cabinet.



7 The electrical system (protected by IP 30) of each computer cabinet is standard supplied with a 230V 10A circuit breaker and tested with a special tester according to the CEI EN 60204-1, with the following tests:
- continuity of the earth circuit
- applied voltage
- insulation resistance



■ Cabinet with or without plinths

Cabinet load capacity: 400 kg
Load capacity of the adjustable shelf: 100 kg
Load capacity of the retractable shelf: 50 kg

■ Cabinet with wheels

Cabinet load capacity: 400 kg.
Load capacity of the adjustable shelf: 100 kg
Load capacity of the retractable shelf: 25 kg*

*Attention: the load capacity may be increased by 100% if the cabinet already contains a 50 kg load.

9 Adjust the external length of the power cable by unscrewing the relative cable holder. The dual protection power cable is 3 metres long.



■ KEY

RAL 7000 F..01 RAL 6011 F..02 RAL 5012 F..04 RAL 7035 F..08



■ All indicated loads are net and refer to evenly distributed weights

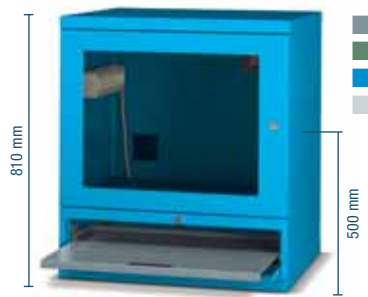

CABINETS SERIES STANDARD CS

**Dimensions mm 717x635x810 h**

Complete with: 1 height adjustable shelf, 1 retractable keyboard shelf

Computer cabinet **ORD. NO. F AS 0801 11 08**

| ORD. NO. with 1 fan | type and number of wired sockets: | | | | | |
|------------------------|-----------------------------------|---|----|---|----|----|
| | D | F | GB | I | CH | IL |
| F AS 0801 11 04 | 5 | - | - | - | - | - |
| F AS 0801 21 04 | 2 | 3 | - | - | - | - |
| F AS 0801 31 04 | 2 | - | 2 | - | - | - |
| F AS 0801 41 04 | 2 | - | - | 3 | - | - |
| F AS 0801 51 04 | 2 | - | - | - | 3 | - |
| F AS 0801 71 04 | 2 | - | - | - | - | 3 |

| ORD. NO. with 2 fans | type and number of wired sockets: | | | | | |
|------------------------|-----------------------------------|---|----|---|----|----|
| | D | F | GB | I | CH | IL |
| F AS 0802 11 04 | 5 | - | - | - | - | - |
| F AS 0802 21 04 | 2 | 3 | - | - | - | - |
| F AS 0802 31 04 | 2 | - | 2 | - | - | - |
| F AS 0802 41 04 | 2 | - | - | 3 | - | - |
| F AS 0802 51 04 | 2 | - | - | - | 3 | - |
| F AS 0802 71 04 | 2 | - | - | - | - | 3 |



RAL 7035

RAL 7000 F... ..01 RAL 6011 F... ..02 RAL 5012 F... ..04 RAL 7035 F... ..08

INFO ■

www.famispa.com

LENGTH = 717 mm DEPTH = 635 mm

CABINETS SERIES STANDARD CS

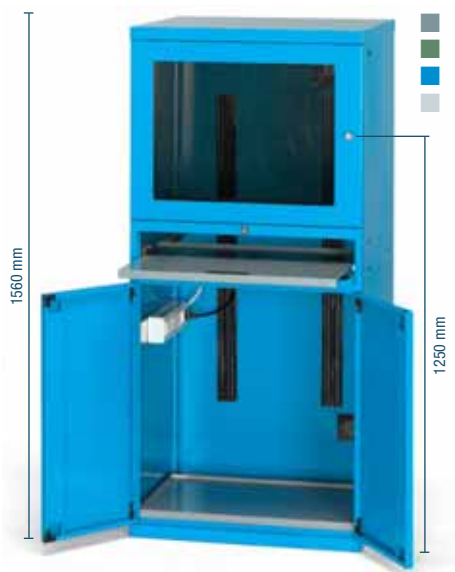

Dimensions mm 717x635x1560 h
complete with: 2 height adjustable shelves, 1 retractable keyboard shelf

| ORD. NO. with 1 fan | type and number of wired sockets: | | | | | |
|---------------------|-----------------------------------|---|----|---|----|----|
| | D | F | GB | I | CH | IL |
| F AS 1601 11 04 | 5 | - | - | - | - | - |
| F AS 1601 21 04 | 2 | 3 | - | - | - | - |
| F AS 1601 31 04 | 2 | - | 2 | - | - | - |
| F AS 1601 41 04 | 2 | - | - | 3 | - | - |
| F AS 1601 51 04 | 2 | - | - | - | 3 | - |
| F AS 1601 71 04 | 2 | - | - | - | - | 3 |

| ORD. NO. with 2 fans | type and number of wired sockets: | | | | | |
|----------------------|-----------------------------------|---|----|---|----|----|
| | D | F | GB | I | CH | IL |
| F AS 1602 11 04 | 5 | - | - | - | - | - |
| F AS 1602 21 04 | 2 | 3 | - | - | - | - |
| F AS 1602 31 04 | 2 | - | 2 | - | - | - |
| F AS 1602 41 04 | 2 | - | - | 3 | - | - |
| F AS 1602 51 04 | 2 | - | - | - | 3 | - |
| F AS 1602 71 04 | 2 | - | - | - | - | 3 |

can contain big tower



Computer cabinet
ORD. NO. F AS 1601 12 04
with 2 multi-purpose supports
ORD. NO. F AS 2250 00 07

"Dark light" lamp with three joints
ORD. NO. F BL 9980 00 08



Cabinet with writing desk **ORD. NO. F AA 0110 00 04** Polyurethane chair **ORD. NO. F QZ 2211 00 07**

KEY

RAL 7000 F... ..01 RAL 6011 F... ..02 RAL 5012 F... ..04 RAL 7035 F... ..08



The cabinets must be secured to the floor



CABINETS SERIES STANDARD CS

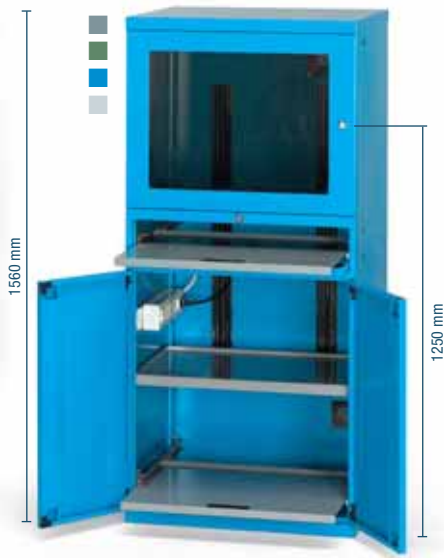

Dim. mm 717x635x1560 h
Complete with:
2 height adjustable shelves
1 retractable keyboard shelf
1 retractable shelf

| ORD. NO. with 1 fan | type and number of wired sockets: | | | | | |
|---------------------|-----------------------------------|---|----|---|----|----|
| | D | F | GB | I | CH | IL |
| F AS 1601 12 04 | 5 | - | - | - | - | - |
| F AS 1601 22 04 | 2 | 3 | - | - | - | - |
| F AS 1601 32 04 | 2 | - | 2 | - | - | - |
| F AS 1601 42 04 | 2 | - | - | 3 | - | - |
| F AS 1601 52 04 | 2 | - | - | - | 3 | - |
| F AS 1601 72 04 | 2 | - | - | - | - | 3 |

| ORD. NO. with 2 fans | type and number of wired sockets: | | | | | |
|----------------------|-----------------------------------|---|----|---|----|----|
| | D | F | GB | I | CH | IL |
| F AS 1602 12 04 | 5 | - | - | - | - | - |
| F AS 1602 22 04 | 2 | 3 | - | - | - | - |
| F AS 1602 32 04 | 2 | - | 2 | - | - | - |
| F AS 1602 42 04 | 2 | - | - | 3 | - | - |
| F AS 1602 52 04 | 2 | - | - | - | 3 | - |
| F AS 1602 72 04 | 2 | - | - | - | - | 3 |

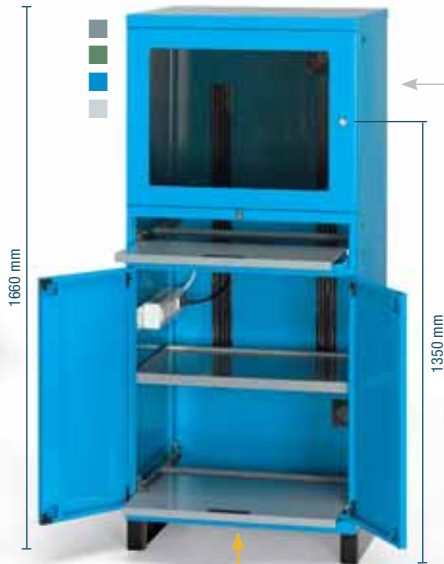

Dim. mm 717x635x1660 h
Complete with:
2 height adjustable shelves
1 retractable keyboard shelf
1 retractable shelf
1 pair of 100 mm h base plinths without facing piece

Facing piece for base plinths 100 mm h



Dim. mm 717x635x1760 h
Complete with:
2 height adjustable shelves
1 retractable keyboard shelf
1 retractable shelf
1 pair of 200 mm h base plinths without facing piece

Facing piece for base plinths 200 mm h



| ORD. NO. with 1 fan | type and number of wired sockets: | | | | | |
|---------------------|-----------------------------------|---|----|---|----|----|
| | D | F | GB | I | CH | IL |
| F AS 1601 14 04 | 5 | - | - | - | - | - |
| F AS 1601 24 04 | 2 | 3 | - | - | - | - |
| F AS 1601 34 04 | 2 | - | 2 | - | - | - |
| F AS 1601 44 04 | 2 | - | - | 3 | - | - |
| F AS 1601 54 04 | 2 | - | - | - | 3 | - |
| F AS 1601 74 04 | 2 | - | - | - | - | 3 |

| ORD. NO. with 2 fans | type and number of wired sockets: | | | | | |
|----------------------|-----------------------------------|---|----|---|----|----|
| | D | F | GB | I | CH | IL |
| F AS 1602 14 04 | 5 | - | - | - | - | - |
| F AS 1602 24 04 | 2 | 3 | - | - | - | - |
| F AS 1602 34 04 | 2 | - | 2 | - | - | - |
| F AS 1602 44 04 | 2 | - | - | 3 | - | - |
| F AS 1602 54 04 | 2 | - | - | - | 3 | - |
| F AS 1602 74 04 | 2 | - | - | - | - | 3 |

| ORD. NO. with 1 fan | type and number of wired sockets: | | | | | |
|---------------------|-----------------------------------|---|----|---|----|----|
| | D | F | GB | I | CH | IL |
| F AS 1601 15 04 | 5 | - | - | - | - | - |
| F AS 1601 25 04 | 2 | 3 | - | - | - | - |
| F AS 1601 35 04 | 2 | - | 2 | - | - | - |
| F AS 1601 45 04 | 2 | - | - | 3 | - | - |
| F AS 1601 55 04 | 2 | - | - | - | 3 | - |
| F AS 1601 75 04 | 2 | - | - | - | - | 3 |

| ORD. NO. with 2 fans | type and number of wired sockets: | | | | | |
|----------------------|-----------------------------------|---|----|---|----|----|
| | D | F | GB | I | CH | IL |
| F AS 1602 15 04 | 5 | - | - | - | - | - |
| F AS 1602 25 04 | 2 | 3 | - | - | - | - |
| F AS 1602 35 04 | 2 | - | 2 | - | - | - |
| F AS 1602 45 04 | 2 | - | - | 3 | - | - |
| F AS 1602 55 04 | 2 | - | - | - | 3 | - |
| F AS 1602 75 04 | 2 | - | - | - | - | 3 |

RAL 7000 F.01

RAL 6011 F.02

RAL 5012 F.04

RAL 7035 F.08

SUPPLEMENTARY PARTS ■



■ All indicated loads are net and refer to evenly distributed weights



- 2 "HILTI" plugs for concrete floors \geq to classes B25/RBK250/MPa 25 N/mm²
- Recommended traction of the plug: 2.9 KN
- Plug diameter: \varnothing 6 mm

ORD. NO. F AG 9204 00 99



LENGTH = 717 mm DEPTH = 635 mm

CABINETS SERIES STANDARD CS

MULTI-PURPOSE SUPPORT



ORD. NO. F AS 2250 00 07

07



4 position for the multi-purpose support (2 to the right side and 2 to the left side of the cabinet).



Cabinet **ORD. NO. F AS 1601 15 04** with base plinth and facing piece **ORD. NO. F RR 0645 01 07**

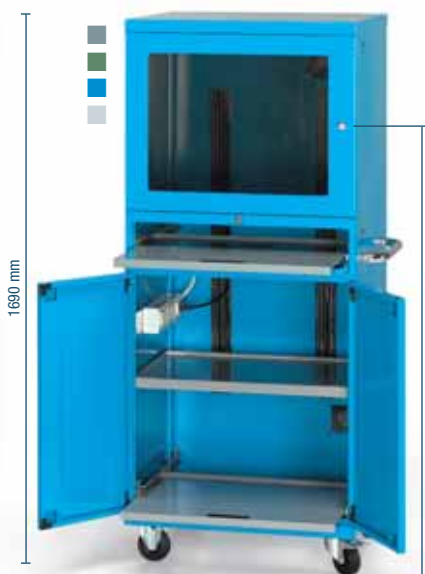

handling with a transpallet



Dim. mm 717x635x1690 h
 Complete with:
 2 height adjustable shelves
 1 retractable keyboard shelf
 1 retractable shelf
 2 swivel nylon wheels with brake
 2 fixed nylon wheels Ø 100 mm

| ORD. NO. | type and number of wired sockets: | | | | | |
|-----------------|-----------------------------------|---|----|---|----|----|
| | D | F | GB | I | CH | IL |
| F AS 1601 13 04 | 5 | - | - | - | - | - |
| F AS 1601 23 04 | 2 | 3 | - | - | - | - |
| F AS 1601 33 04 | 2 | - | 2 | - | - | - |
| F AS 1601 43 04 | 2 | - | - | 3 | - | - |
| F AS 1601 53 04 | 2 | - | - | - | 3 | - |
| F AS 1601 73 04 | 2 | - | - | - | - | 3 |

| ORD. NO. | type and number of wired sockets: | | | | | |
|-----------------|-----------------------------------|---|----|---|----|----|
| | D | F | GB | I | CH | IL |
| F AS 1602 13 04 | 5 | - | - | - | - | - |
| F AS 1602 23 04 | 2 | 3 | - | - | - | - |
| F AS 1602 33 04 | 2 | - | 2 | - | - | - |
| F AS 1602 43 04 | 2 | - | - | 3 | - | - |
| F AS 1602 53 04 | 2 | - | - | - | 3 | - |
| F AS 1602 73 04 | 2 | - | - | - | - | 3 |



CABINETS SERIES STANDARD CS

LENGTH = 717 mm DEPTH = 635 mm

EMPTY CABINET



| ORD. NO. | LOAD CAPACITY kg |
|---|------------------|
| F AS 1600 01 04 | 400 |
| overall dimensions mm 717x635x1560 h | |
| Int. dim. of upper compartment mm 690x600x580 h | |
| Int. dim. of lower compartment mm 690x600x720 h | |
| Attention: to the computer cabinet it is possible to apply wheels with Ø 100/125/150 mm only | |
| ■ Wheels see page A52 | |

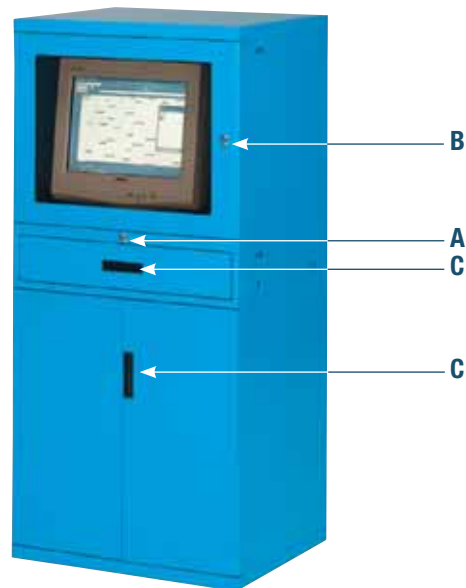

| ORD. NO. |
|---|
| R CSR 0027 00 |
| Spare lock (for central lock) ref. A |
| R CSR 0026 00 |
| Spare lock (for polycarbonate doors) ref. B |
| R XAS 0002 99 |
| Spare rod (for pair of doors) |
| R XDA 0002 07 |
| Spare handle (for doors) ref. C |



RETRACTABLE SHELF

| ORD. NO. | LOAD CAPACITY kg |
|---|------------------|
| F AS 2360 00 01 | 50 |
| Overall dimensions mm 650x585x25 h | |
| Usable dimensions mm 620x510 | |



RETRACTABLE KEYBOARD SHELF

| ORD. NO. | LOAD CAPACITY kg |
|---|------------------|
| F AS 2350 00 01 | 5 |
| Overall dimensions mm 650x585x25 h | |
| Usable dimensions mm 620x510 | |



ADJUSTABLE SHELF

| ORD. NO. | LOAD CAPACITY kg |
|---|------------------|
| F AS 2040 01 01 | 100 |
| Overall dimensions mm 690x595x35 h | |
| Usable dimensions mm 685x510 | |



PAIR OF PLINTHS FOR TRANSPALLET 100 mm h

| ORD. NO. |
|------------------------|
| F RR 1625 00 07 |
| Plinths height 100 mm |
| F RR 0645 00 07 |
| Facing piece |



PAIR OF PLINTHS 200 mm h

| ORD. NO. |
|------------------------|
| F RR 1635 00 07 |
| Plinths height 200 mm |
| F RR 0645 01 07 |
| Facing piece |

RAL 7000 F.01 RAL 6011 F.02 RAL 5012 F.04 RAL 7035 F.08

SUPPLEMENTARY PARTS ■



■ All indicated loads are net and refer to evenly distributed weights



■ **Spare key.** Always indicate the number on the cylinder lock of the key to be replaced.

ORD. NO. R CSC 0002 00

■ **Master key.** This type of key opens all the 45 and 46 series locks.

ORD. NO. R CSC 0001 00



LENGTH = 717 mm DEPTH = 635 mm

CABINETS SERIES STANDARD CS

**PROFILE****ORD. NO.****C ME 99 018**

1000 mm long 4-channel plastic cable duct

**GRILLES****ORD. NO.****F AS 3210 00 00**

External grille complete with dust filter

**HANDLE****ORD. NO.****F AG 9300 00 07****FAN****ORD. NO.****F AS 3220 00 00**

220V wired fan complete with grilles and Schuko plug

ELECTRICAL SYSTEM

The electrical system (protected by **IP 30**) is supplied with one 230V 10A circuit breaker, five 220-250V 10A 2P+E sockets and one 220-250V 16A 2P+E heavy-duty plug

| ORD. NO. | type and number of wired sockets: | | | | | |
|------------------------|-----------------------------------|---|----|---|----|----|
| | D | F | GB | I | CH | IL |
| F AS 4100 10 00 | 5 | - | - | - | - | - |
| F AS 4100 20 00 | 2 | 3 | - | - | - | - |
| F AS 4100 30 00 | 2 | - | 2 | - | - | - |
| F AS 4100 40 00 | 2 | - | - | 3 | - | - |
| F AS 4100 50 00 | 2 | - | - | - | 3 | - |
| F AS 4100 70 00 | 2 | - | - | - | - | 3 |

■ INFO

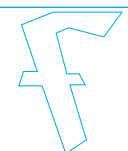
www.famispa.com

SERIES STANDARD H

**1 Eh = 17 mm**

1 Eh (17 mm)
corresponds to the pitch of the slots and
of the perforations of the drawer.

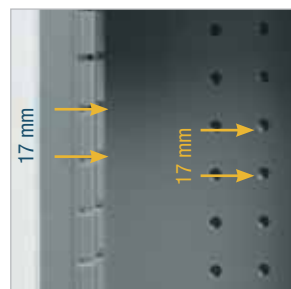

GALVANISED
F.99

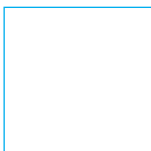
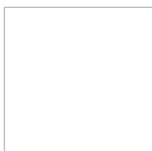
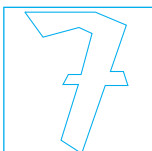

INFO ■

www.famispa.com



1 EH = 17 mm

SERIES STANDARD H

PLAIN PARTITIONS



FOR FRONT HEIGHTS

| | ORD. NO. Lengths 24 Eh (405 mm) | ORD. NO. Lengths 27 Eh (455 mm) | ORD. NO. Lengths 30 Eh (507 mm) | ORD. NO. Lengths 36 Eh (610 mm) | ORD. NO. Lengths 54 Eh (914 mm) | ORD. NO. Lengths 64 Eh (1085 mm) | ORD. NO. Lengths 78 Eh (1323 mm) |
|---------|------------------------------------|------------------------------------|------------------------------------|------------------------------------|------------------------------------|-------------------------------------|-------------------------------------|
| 50 | F HA 2110 00 99 | F HA 2120 00 99 | F HA 2130 00 99 | F HA 2140 00 99 | F HA 2150 00 99 | - | - |
| 75 | F HA 2210 00 99 | F HA 2220 00 99 | F HA 2230 00 99 | F HA 2240 00 99 | F HA 2250 00 99 | F HA 2260 00 99 | F HA 2270 00 99 |
| 100-125 | F HA 2310 00 99 | F HA 2320 00 99 | F HA 2330 00 99 | F HA 2340 00 99 | F HA 2350 00 99 | F HA 2360 00 99 | F HA 2370 00 99 |
| 150-175 | F HA 2410 00 99 | F HA 2420 00 99 | F HA 2430 00 99 | F HA 2440 00 99 | F HA 2450 00 99 | F HA 2460 00 99 | F HA 2470 00 99 |
| 200-250 | F HA 2510 00 99 | F HA 2520 00 99 | F HA 2530 00 99 | F HA 2540 00 99 | F HA 2550 00 99 | F HA 2560 00 99 | F HA 2570 00 99 |
| 300-400 | - | - | - | F HA 2640 00 99 | F HA 2650 00 99 | F HA 2660 00 99 | F HA 2670 00 99 |

SLOTTED PARTITIONS



FOR FRONT HEIGHTS

| | ORD. NO. Lengths 17 Eh (286 mm) | ORD. NO. Lengths 27 Eh (455 mm) | ORD. NO. Lengths 30 Eh (507 mm) | ORD. NO. Lengths 36 Eh (610 mm) | ORD. NO. Lengths 54 Eh (914 mm) | ORD. NO. Lengths 64 Eh (1085 mm) | ORD. NO. Lengths 78 Eh (1323 mm) |
|---------|------------------------------------|------------------------------------|------------------------------------|------------------------------------|------------------------------------|-------------------------------------|-------------------------------------|
| 50 | F HA 1110 00 99 | F HA 1120 00 99 | F HA 1130 00 99 | F HA 1140 00 99 | F HA 1150 00 99 | - | - |
| 75 | - | F HA 1220 00 99 | F HA 1230 00 99 | F HA 1240 00 99 | F HA 1250 00 99 | F HA 1260 00 99 | F HA 1270 00 99 |
| 100-125 | - | F HA 1320 00 99 | F HA 1330 00 99 | F HA 1340 00 99 | F HA 1350 00 99 | F HA 1360 00 99 | F HA 1370 00 99 |
| 150-175 | - | F HA 1420 00 99 | F HA 1430 00 99 | F HA 1440 00 99 | F HA 1450 00 99 | F HA 1460 00 99 | F HA 1470 00 99 |
| 200-250 | - | F HA 1520 00 99 | - | F HA 1540 00 99 | F HA 1550 00 99 | F HA 1560 00 99 | F HA 1570 00 99 |
| 300-400 | - | F HA 1620 00 99 | - | F HA 1640 00 99 | F HA 1650 00 99 | F HA 1660 00 99 | F HA 1670 00 99 |

SINGLE-SIDED SLOTTED PARTITIONS



FOR FRONT HEIGHTS

| | ORD. NO. Lengths 27 Eh (455 mm) | ORD. NO. Lengths 36 Eh (610 mm) |
|----|------------------------------------|------------------------------------|
| 50 | F HA 1121 00 99 | F HA 1141 00 99 |

■ INFO

GALVANISED
F. 99



www.famispa.com

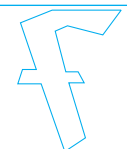

1 EH = 17 mm

SERIES STANDARD H

PLAIN PARTITIONS



FOR FRONT HEIGHTS

| | ORD. NO. Lengths 2 Eh (30 mm) | ORD. NO. Lengths 3 Eh (47 mm) | ORD. NO. Lengths 4 Eh (64 mm) | ORD. NO. Lengths 5 Eh (81 mm) | ORD. NO. Lengths 6 Eh (98 mm) | ORD. NO. Lengths 7 Eh (115 mm) |
|---------|----------------------------------|----------------------------------|----------------------------------|----------------------------------|----------------------------------|-----------------------------------|
| 50 | F HA 3105 00 00 | F HA 3110 00 00 | F HA 3115 00 00 | F HA 3120 00 00 | F HA 3125 00 00 | F HA 3130 00 00 |
| 75 | - | F HA 3210 00 00 | F HA 3215 00 00 | F HA 3220 00 00 | F HA 3225 00 00 | F HA 3230 00 00 |
| 100-125 | - | F HA 3310 00 00 | F HA 3315 00 00 | F HA 3320 00 00 | F HA 3325 00 00 | F HA 3330 00 00 |
| 150-175 | - | - | - | - | F HA 3425 00 00 | F HA 3430 00 00 |
| 200-250 | - | - | - | - | - | F HA 3530 00 00 |
| 300-400 | - | - | - | - | - | - |

FOR FRONT HEIGHTS

| | ORD. NO. Lengths 8 Eh (132 mm) | ORD. NO. Lengths 9 Eh (149 mm) | ORD. NO. Lengths 10 Eh (166 mm) | ORD. NO. Lengths 12 Eh (200 mm) | ORD. NO. Lengths 15 Eh (251 mm) | ORD. NO. Lengths 18 Eh (302 mm) |
|---------|-----------------------------------|-----------------------------------|------------------------------------|------------------------------------|------------------------------------|------------------------------------|
| 50 | F HA 3135 00 00 | F HA 3140 00 00 | F HA 3145 00 00 | F HA 3150 00 00 | F HA 3155 00 00 | F HA 3160 00 00 |
| 75 | F HA 3235 00 00 | F HA 3240 00 00 | F HA 3245 00 00 | F HA 3250 00 00 | F HA 3255 00 00 | F HA 3260 00 00 |
| 100-125 | F HA 3335 00 00 | F HA 3340 00 00 | F HA 3345 00 00 | F HA 3350 00 00 | F HA 3355 00 00 | F HA 3360 00 00 |
| 150-175 | F HA 3435 00 00 | F HA 3440 00 00 | F HA 3445 00 00 | F HA 3450 00 00 | F HA 3455 00 00 | F HA 3460 00 00 |
| 200-250 | F HA 3535 00 00 | F HA 3540 00 00 | F HA 3545 00 00 | F HA 3550 00 00 | F HA 3555 00 00 | F HA 3560 00 00 |
| 300-400 | - | F HA 3640 00 00 | F HA 3645 00 00 | F HA 3650 00 00 | F HA 3655 00 00 | F HA 3660 00 00 |

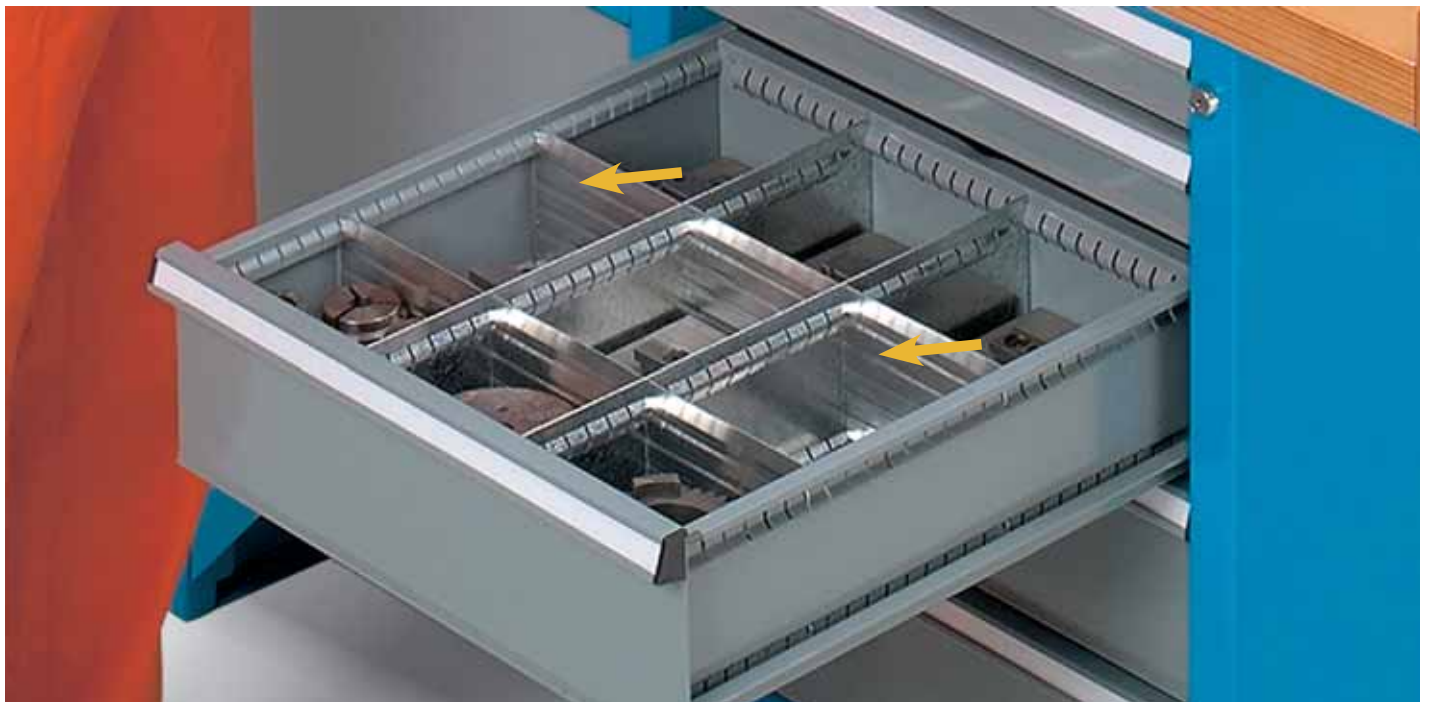

ALUMINUM F.,00

INFO ■

www.famispa.com



1 EH = 17 mm

SERIES STANDARD H

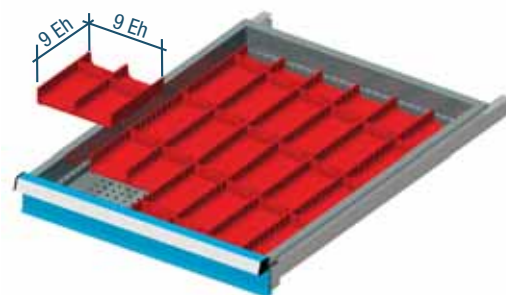
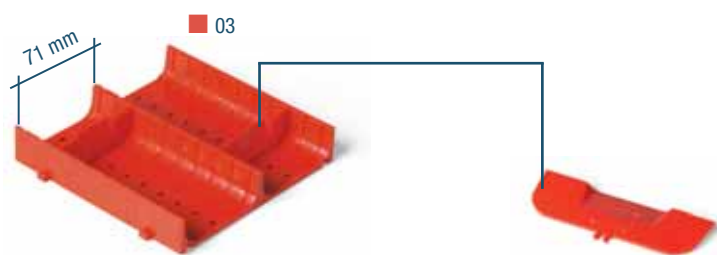

SERIES STANDARD H

TROUGHES



Trough with 2 grooves **9x9 Eh** Dimensions mm

ORD. NO. F HC 3071 00 03 150x150x28 h

For tools Ø max. 70 mm

Trough divider 73 mm

ORD. NO. F HC 1871 00 03

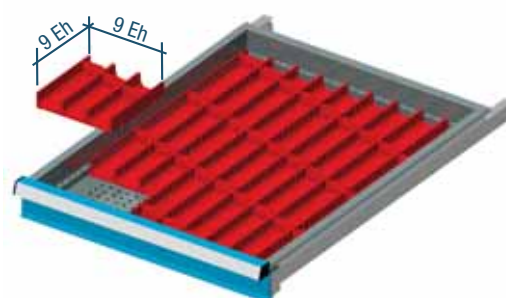

Trough with 3 grooves **9x9 Eh** Dimensions mm

ORD. NO. F HC 3471 00 03 150x150x28 h

For tools Ø max. 45 mm

Trough divider 47 mm

ORD. NO. F HC 1471 00 03

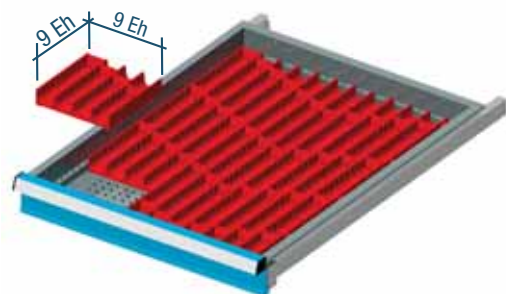
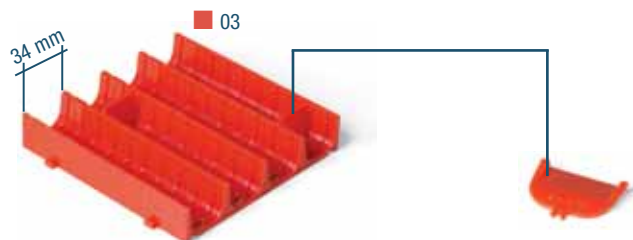

Trough with 4 grooves **9x9 Eh** Dimensions mm

ORD. NO. F HC 3871 00 03 150x150x28 h

For tools Ø max. 33 mm

Trough divider 36 mm

ORD. NO. F HC 1071 00 03



1 EH = 17 mm

SERIES STANDARD H

PLASTIC BOXES

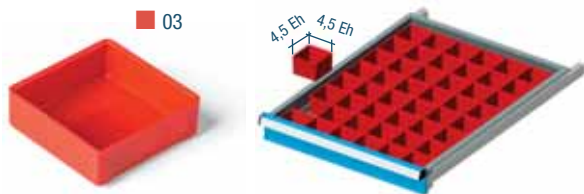

| FOR FRONT HEIGHTS | ORD. NO. Plastic boxes 4,5x4,5 Eh | Dimensions mm |
|-------------------|--------------------------------------|------------------|
| 50 | F HC 4471 00 03 | 75x75x26 h |
| 75 | F HC 6071 00 03 | 75x75x52 h |

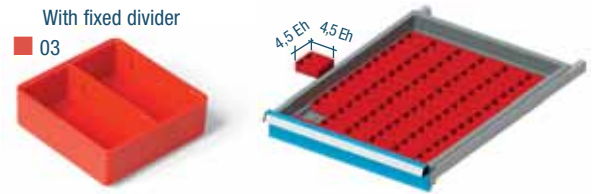

| FOR FRONT HEIGHTS | ORD. NO. Plastic boxes 4,5x4,5 Eh | Dimensions mm |
|-------------------|--------------------------------------|------------------|
| 50 | F HC 4071 00 03 | 75x75x26 h |

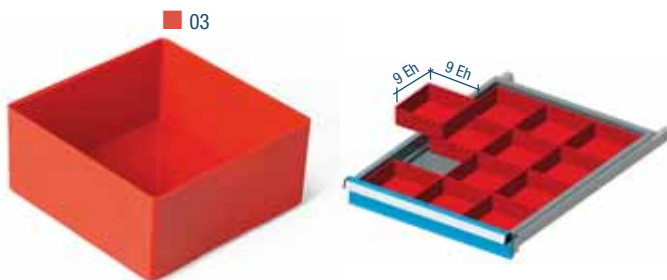

| FOR FRONT HEIGHTS | ORD. NO. Plastic boxes 9x9 Eh | Dimensions mm |
|-------------------|----------------------------------|------------------|
| 50 | F HC 5271 00 03 | 150x150x26 h |
| 75 | F HC 6871 00 03 | 150x150x52 h |
| 100-125 | F HC 7671 00 03 | 150x150x71 h |

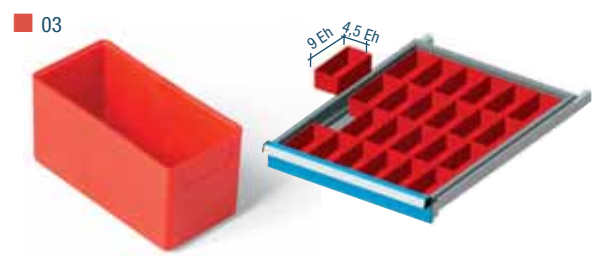

| FOR FRONT HEIGHTS | ORD. NO. Plastic boxes 9x4,5 Eh | Dimensions mm |
|-------------------|------------------------------------|------------------|
| 50 | F HC 4871 00 03 | 150x75x26 h |
| 75 | F HC 6471 00 03 | 150x75x52 h |
| 100-125 | F HC 7271 00 03 | 150x75x71 h |



Divider for boxes F HC 5671

ORD. NO. F HC 8071 00 03

Example of use of the central divider

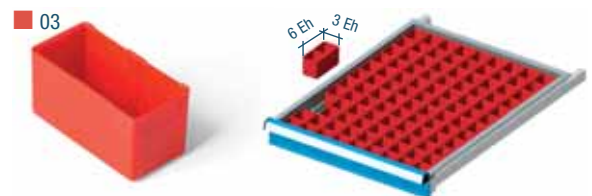

| FOR FRONT HEIGHTS | ORD. NO. Plastic boxes 6x3 Eh | Dimensions mm |
|-------------------|----------------------------------|------------------|
| 75 | F HC 5671 00 03 | 100x50x52 h |

LABEL HOLDER

Label holder including plastic cover + labels

ORD. NO. F HC 9071 00 03

Not suitable for F HC 5671 00 03

Additional labels including plastic covers

ORD. NO. R FHD 0002 00

Package of: 84 pz



■ INFO



www.famispaspa.com

RED F... .. 03

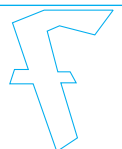

SERIES STANDARD H

CUTTER HOLDERS



■ 03

Tool identification label pin Ø 3 mm 26 mm h

ORD. NO. F HD 0250 00 99

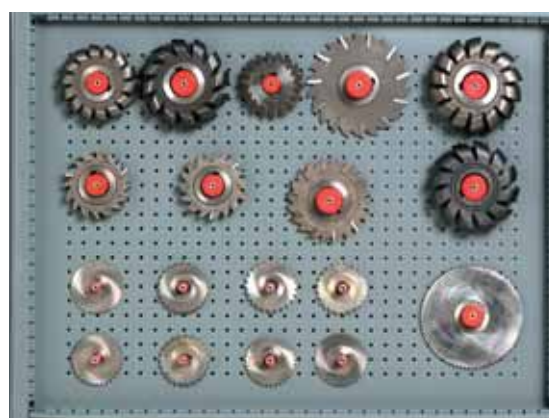
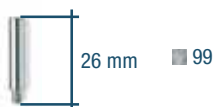

| ORD. NO. CUTTER HOLDERS | Cutter holders Ø mm | Hole DIN Tool mm | Height mm |
|-------------------------|---------------------|------------------|-----------|
| F HD 2071 00 03 | 12,2 | 13 | 26 |
| F HD 2371 00 03 | 15,5 | 16 | 26 |
| F HD 2671 00 03 | 21,5 | 22 | 26 |
| F HD 2971 00 03 | 26,5 | 27 | 26 |
| F HD 3271 00 03 | 31,2 | 32 | 26 |
| F HD 3571 00 03 | 39,5 | 40 | 26 |
| F HD 3871 00 03 | 49,5 | 50 | 26 |
| F HD 4171 00 03 | 1 | - | 26 |
| F HD 4471 00 03 | 1,½ | - | 26 |

TOOL IDENTIFICATION LABEL BOXES

Label boxes dim. mm 65x25x30 h

ORD. NO. F HD 8271 00 03

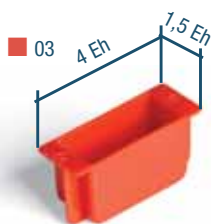

The tool identification label containers must be combined with the following slotted partitions:

ORD. NO. F HA 1140 00 99 for 600 mm long drawers (36 Eh)

ORD. NO. F HA 1120 00 99 for 447 mm long drawers (27 Eh)

RED F... 03 GALVANISED F... 99

INFO ■

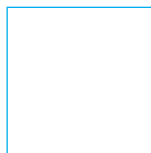
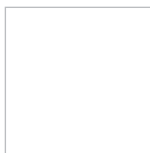
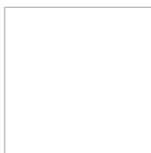
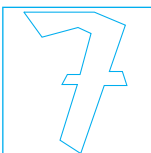

www.famispa.com

1 EH = 17 mm

SERIES STANDARD H

ANGLE-GROOVED TRAYS



PLAIN PARTITION WIDTH 9 EH

ORD. NO. F HA 3140 00 00 This partition must be combined with the following slotted partitions:

ORD. NO. F HA 1140 00 99 for long drawers 600 mm (36 Eh)

ORD. NO. F HA 1120 00 99 for long drawers 447 mm (27 Eh)

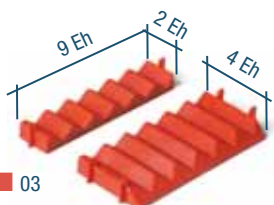

03

Angle tray with 6 grooves for tools max. Ø 20 mm

ORD. NO. F HD 1871 00 03

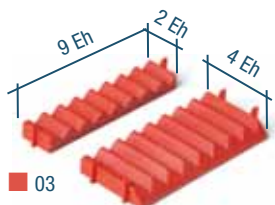

03

Angle tray with 8 grooves for tools max. Ø 14 mm

ORD. NO. F HD 1471 00 03

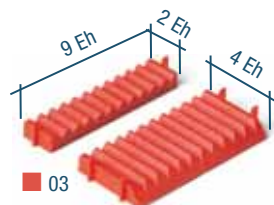

03

Angle tray with 11 grooves for tools max. Ø 8 mm

ORD. NO. F HD 1071 00 03



03

FOR FRONT HEIGHTS

ORD. NO. Label holders

H mm

50
75-100

F HD 0105 00 00
F HD 0110 00 00

25
50

ALLEN KEY TRAY

ORD. NO.

F HD 9271 00 03

Dimensions mm

150x150x26 h

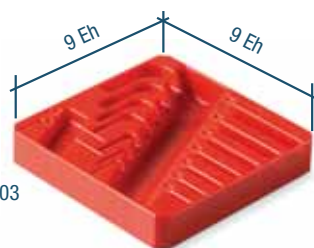

03

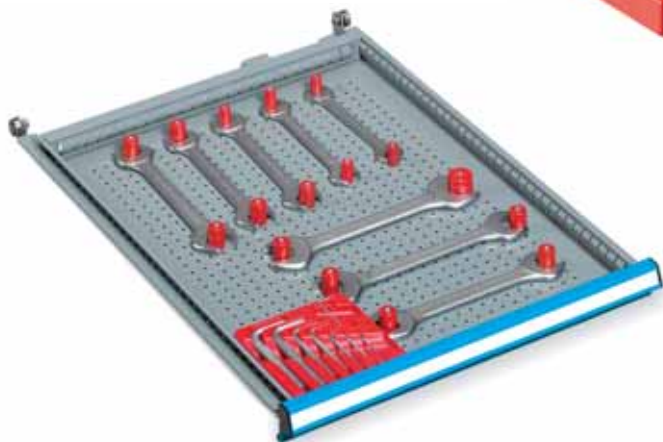

INFO

GALVANISED
F... ..99

RED
F... ..03



www.famispa.com



SERIES STANDARD H

PAIR OF ARBOR HOLDERS

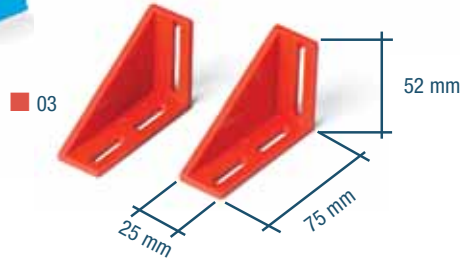
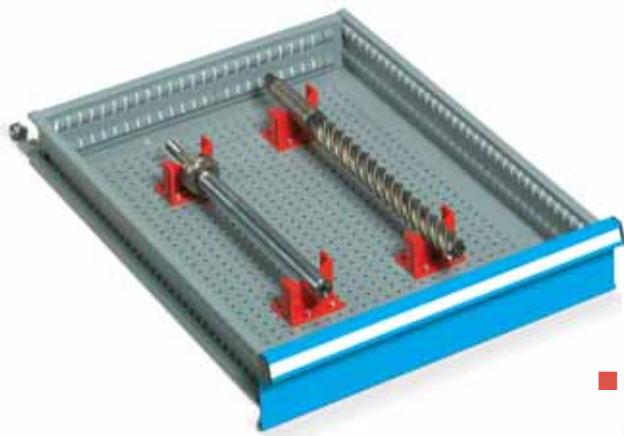

Pair of arbor holders

ORD. NO. F HD 5071 00 03

MULTI-PURPOSE SUPPORTS

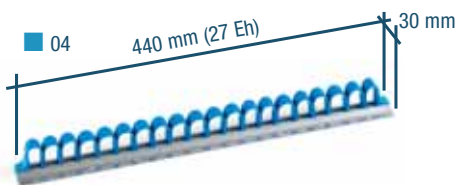

Multi-purpose supports

Dimensions mm

ORD. NO. F HD 7271 00 04

440x30x35 h

MULTI-PURPOSE SUPPORTS

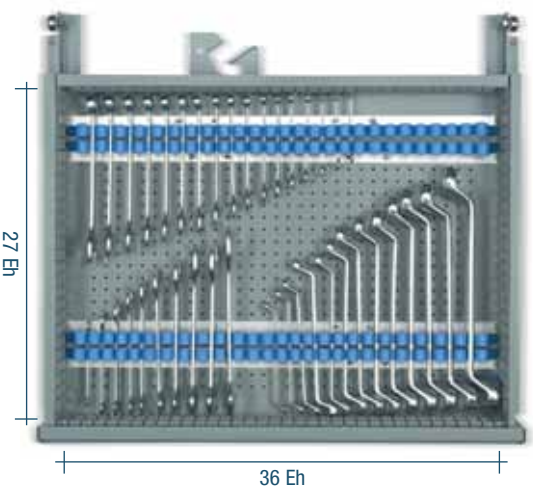
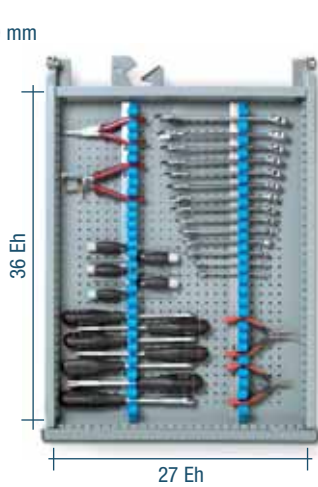
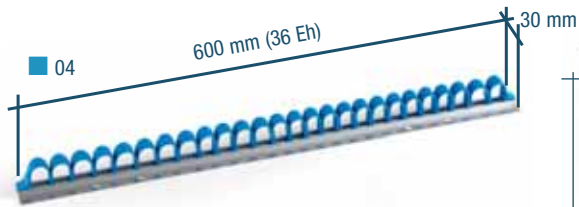

Multi-purpose supports

Dimensions mm

ORD. NO. F HD 7571 00 04

600x30x35 h

RED F.....03 BLUE F.....04

INFO ■



1 EH = 17 mm

SERIES STANDARD H

LOCATION PINS

| | | | |
|------|--|--------------------------|---|
| ■ 99 | | FOR FRONT HEIGHTS | ORD. NO. Location pins Ø 6 mm 27 mm h |
| | | 50 | F HD 0210 00 99 |
| ■ 99 | | FOR FRONT HEIGHTS | ORD. NO. Location pins Ø 6 mm 52 mm h |
| | | 75 | F HD 0215 00 99 |
| ■ 99 | | FOR FRONT HEIGHTS | ORD. NO. Location pins Ø 6 mm 77 mm h |
| | | 100-125 | F HD 0220 00 99 |



SLIDING SHELF



Sliding shelf Dimensions mm
ORD. NO. F HD 0310 00 99 470x200x30 h

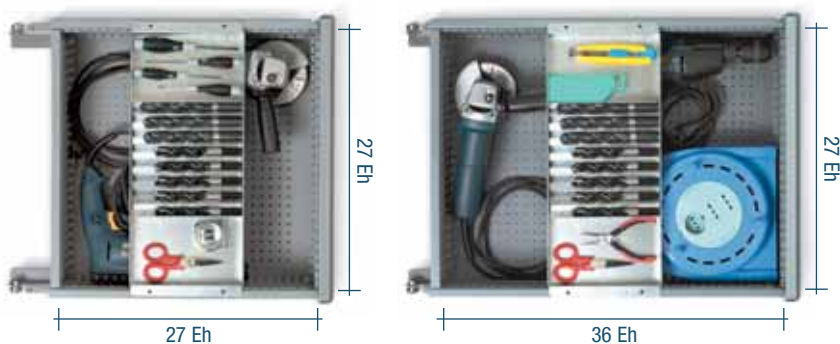

■ Only for width 447 mm (27 Eh)

■ INFO



www.famispaspa.com

GALVANISED
F... ..99



SERIES STANDARD H

FOAM BASE FOR DRAWERS

| FOR DRAWERS | ORD. NO. | Foam base for drawers | Dimensions mm |
|-------------|-----------------|-----------------------|---------------|
| 54x27 Eh | F HD 6171 00 00 | | 905x450x10 h |
| 54x36 Eh | F HD 6471 00 00 | | 905x600x10 h |
| 27x27 Eh | F HD 5471 00 00 | | 450x450x10 h |
| 36x27 Eh | F HD 5571 00 00 | | 605x450x10 h |
| 36x36 Eh | F HD 5871 00 00 | | 605x605x10 h |



NON-SLIP RUBBER

| FOR DRAWERS | ORD. NO. | Non-slip rubber | Dimensions mm |
|-------------|-----------------|-----------------|---------------|
| 19x27 Eh | F HD 6505 00 07 | | 323x450x3 h |
| 27x27 Eh | F HD 6510 00 07 | | 450x450x3 h |
| 36x27 Eh | F HD 6515 00 07 | | 600x450x3 h |
| 54x27 Eh | F HD 6525 00 07 | | 905x450x3 h |
| 27x36 Eh | F HD 6560 00 07 | | 450x600x3 h |
| 36x36 Eh | F HD 6565 00 07 | | 600x600x3 h |
| 45x36 Eh | F HD 6570 00 07 | | 758x600x3 h |
| 54x36 Eh | F HD 6575 00 07 | | 905x600x3 h |
| 64x36 Eh | F HD 6580 00 07 | | 1081x600x3 h |
| 78x36 Eh | F HD 6585 00 07 | | 1319x600x3 h |



ROLL

| FOR DEPTH | ORD. NO. | Non-slip rubber | Dimensions mm |
|-----------|------------|-----------------|----------------|
| 27 Eh | CMV 99 201 | | 10.000x450x3 h |
| 36 Eh | CMV 99 202 | | 10.000x600x3 h |



PAIR OF GUIDE RAILS FOR SUSPENSION FOLDERS

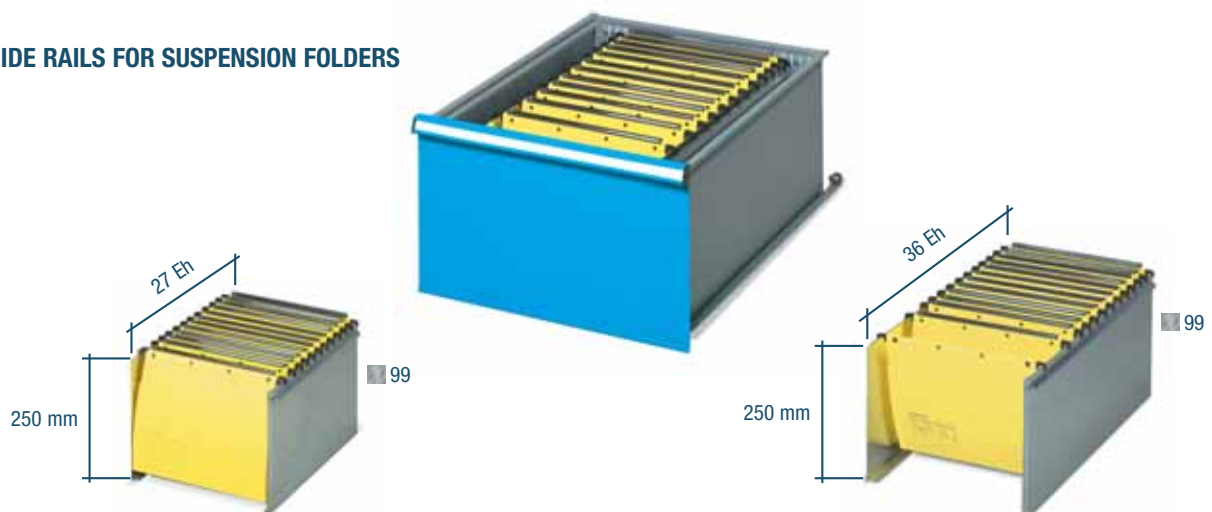

| FRONT HEIGHT | ORD. NO. | Pair of guide | For drawer depth |
|--------------|-----------------|---------------|------------------|
| 300 | F HD 0460 00 99 | | 27 Eh |

| FRONT HEIGHT | ORD. NO. | Pair of guide | For drawer depth |
|--------------|-----------------|---------------|------------------|
| 300 | F HD 0465 00 99 | | 36 Eh |

GALVANISED
F... ..99

INFO ■



1 EH = 17 mm

SERIES STANDARD H



CABINET

ORD. NO.

DRAWERS

F DF B560 03 04

6

Cabinet with 6 full extension drawers

Ø 125 mm standard rubber wheels

Cabinet load capacity: 225 kg

Dimensions mm 792x600x920 h

Central lock

PARTITIONING MATERIAL SET FOR 6 DRAWERS 36x27 EH

ORD. NO.

F FH 9907 01 00

Capacity of up to 170 tools

This set is suitable for the ORD. NO. F DF B560 03.. cabinet set (see above)

The drawers and tools are not included in this set

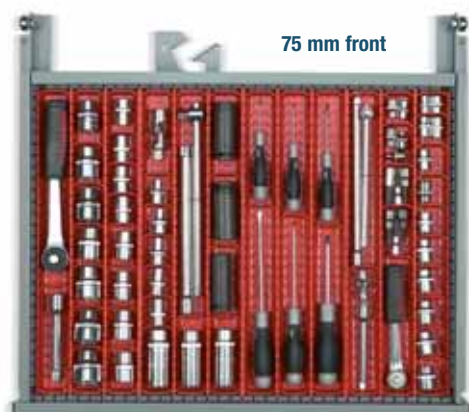

75 mm front



75 mm front

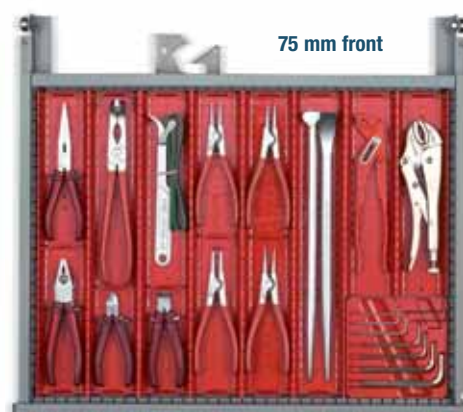

75 mm front

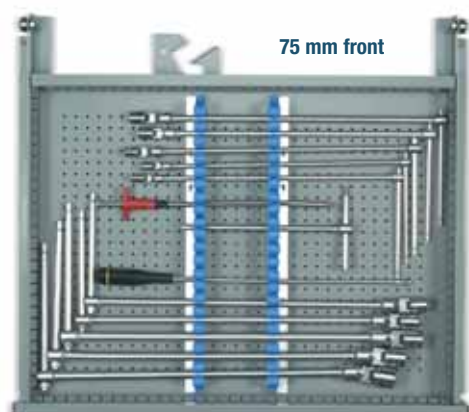

75 mm front

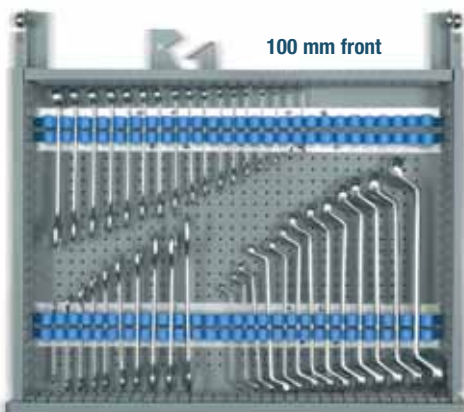

100 mm front



200 mm front

